



Serrures et paumelles
Locksets and hinges

 **Stremmer**

ASSA ABLOY

Serrures *Locksets*

LAGUNE

Caractéristiques techniques générales

- Montage sur encoche 64A
- Réversible
- À cylindre européen panneton DIN (norme DIN 18254)
- Rappel du pêne à la clé
- Pour porte en verre trempé de 8 mm
- Pour verre trempé de 10 mm commander 1 référence S229.81.0 (4 joints de 1 mm) Sauf 4300.30.4, 4300.31.4, 4309.30.4, 4309.31.4
- Condamnation par clé avec avancement du pêne
- Possibilités de combinaison avec passe général
- Livrée avec gâche plate et 3 clés

General technical features

- To fit notch 64A
- Reversible
- European profile cylinder (DIN standard 18254)
- Return of latch bolt by key
- For toughened glass doors 8 mm thick
- For toughened glass of 10 mm order 1 ref S229.81.0 (4 spacers of 1 mm) Except for 4300.30.4, 4300.31.4, 4309.30.4, 4309.31.4
- Locked by key with forward motion of latch bolt
- Possibility of combinations with master key
- Supplied with flat keep and 3 keys

LES + PRODUITS

The + product

Design

Certifié TUV

Nombreuses
versions

Réversible

Elegant Design

TUV certified

Large variety
of models

Reversible

4300

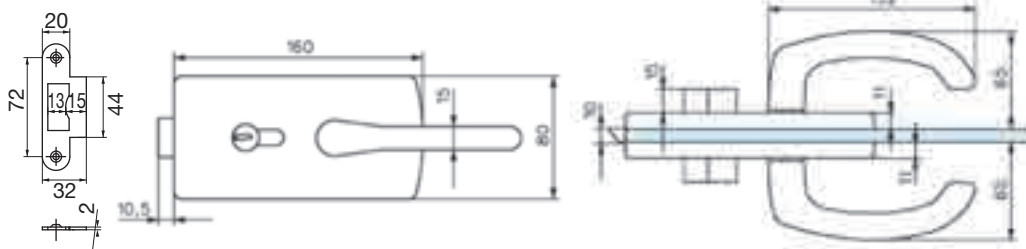
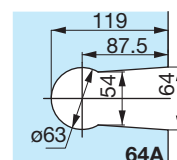

Références / References

Serrure de milieu à cylindre
et double béquilles
Lock with euro profile cylinder
and pair of handles



Laiton poli
Polished brass



Chromé brillant
Bright chromium



Chromé mat
Matt chromium



Doré
Gold plated



Laqué blanc 9010
Lacquered white RAL 9010



4300.00.0

4300.30.0

4300.31.0

4300.40.0

4300.51.0



4300.30.4

4300.31.4

4350

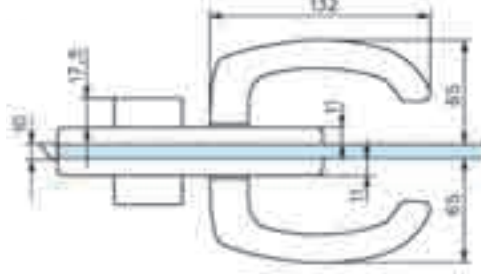
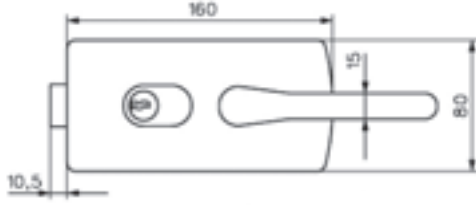
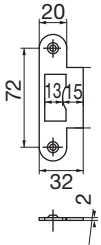
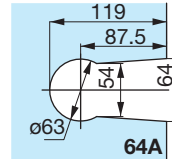

Références / References



Chromé brillant
Bright chromium



Chromé mat
Matt chromium



Doré
Gold plated



Laqué blanc 9010
Lacquered white RAL 9010

Serrure de milieu à cylindre et double béquilles, caches cylindre
Lock with euro profile cylinder pair of handles and cylinder cover

4350.30.0

4350.31.0

4350.40.0

4350.51.0

4309.**.0

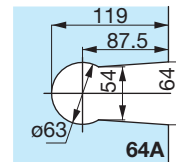

Références / References

Boîtier gâche pour serrures séries 4300-4310-4350
Matching patch keep for locks series 4300-4310-4350



Laiton poli
Polished brass



Chromé brillant
Bright chromium



Chromé mat
Matt chromium



Doré
Gold plated



Laqué blanc 9010
Lacquered white RAL 9010



4309.00.0

4309.30.0

4309.31.0

4309.40.0

4309.51.0



4309.30.4

4309.31.4

0309



Gâche équerre pour serrures séries 4300-4310-4350
Keep plate with stop for locks series 4300-4310-4350

0309.30.0

0309.31.0

0309.51.0

4306

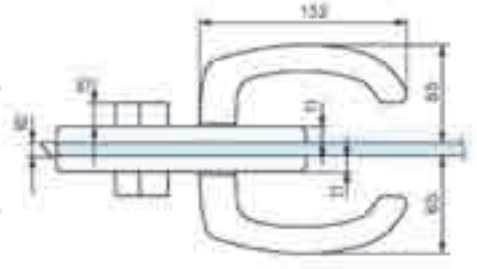
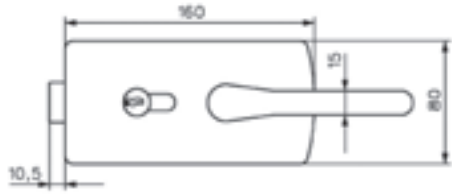
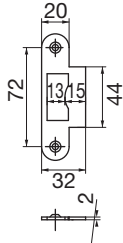
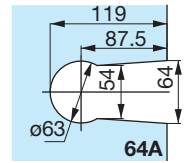

Références / References



Laiton poli
Polished brass



Chromé brillant
Bright chromium



Chromé mat
Matt chromium

Serrure de milieu à cylindre et béquilles condamnation sans avancement du pêne

Lock with euro profile cylinder and double handles, without forward motion of latch bolt

4306.00.0

4306.30.0

4306.31.0

4301

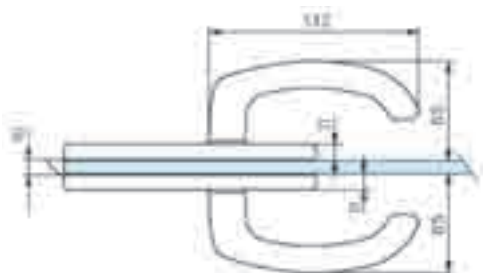
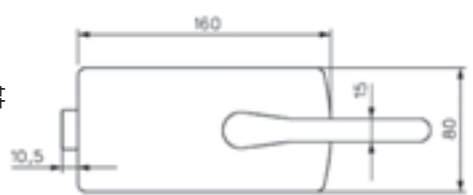
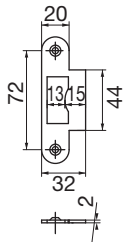
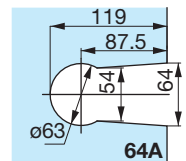

Références / References



Laiton poli
Polished brass



Chromé brillant
Bright chromium



Chromé mat
Matt chromium



Doré
Gold plated



Laqué blanc 9010
Lacquered white RAL 9010

Serrure de milieu bec de cane et double béquilles

Latch set with pair of handles

4301.00.0

4301.30.0

4301.31.0

4301.40.0

4301.51.0

4307

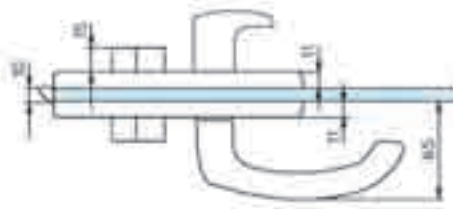
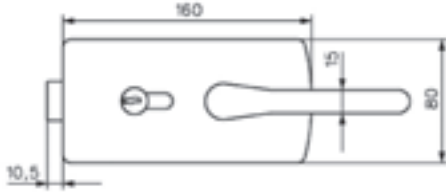
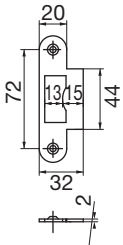
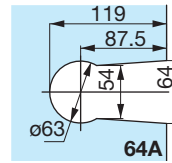

Références / References



Laiton poli
Polished brass



Chromé brillant
Bright chromium



Chromé mat
Matt chromium

Serrure de milieu à cylindre avec béquille intérieure et bouton fixe extérieur, condamnation sans avancement du pêne
Lock with euro profile cylinder, lever handle inside and fixed knob outside, without forward motion of latch bolt

4307.00.0

4307.30.0

4307.31.0

4310

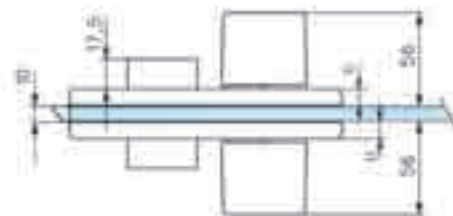
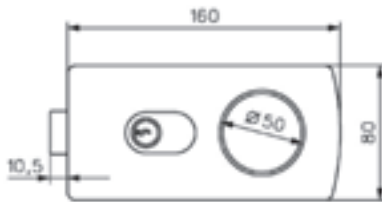
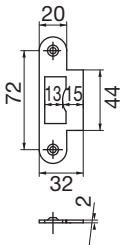
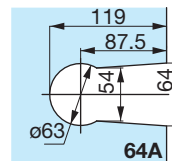

Références / References



Chromé brillant
Bright chromium



Chromé mat
Matt chromium



Doré
Gold plated

Serrure de milieu à cylindre et boutons de manoeuvre avec caches cylindre
Lock with euro profile cylinder and pair of knobs with cylinder covers

4310.30.0

4310.31.0

4310.40.0

4311

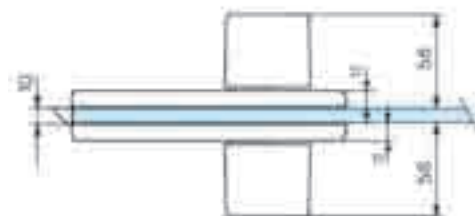
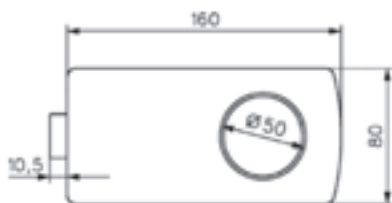
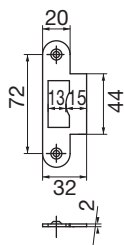
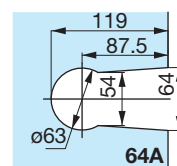

Références / References



Chromé brillant
Bright chromium



Chromé mat
Matt chromium



Doré
Gold plated

Serrure de milieu bec de cane et boutons de manoeuvre
Latch lock with pair of knobs

4311.30.0

4311.31.0

4311.40.0

4312

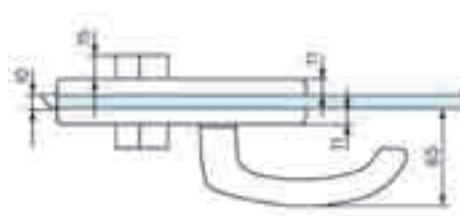
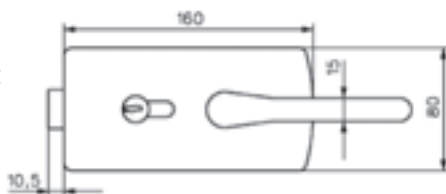
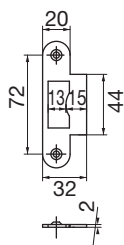
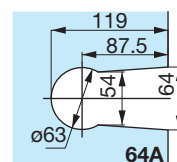

Références / References



Laiton poli
Polished brass



Chromé brillant
Bright chromium



Chromé mat
Matt chromium

Serrure de milieu à cylindre avec une seule béquille intérieure
Lock with euro profile cylinder and lever handle inside only

4312.00.0

4312.30.0

4312.31.0

4314

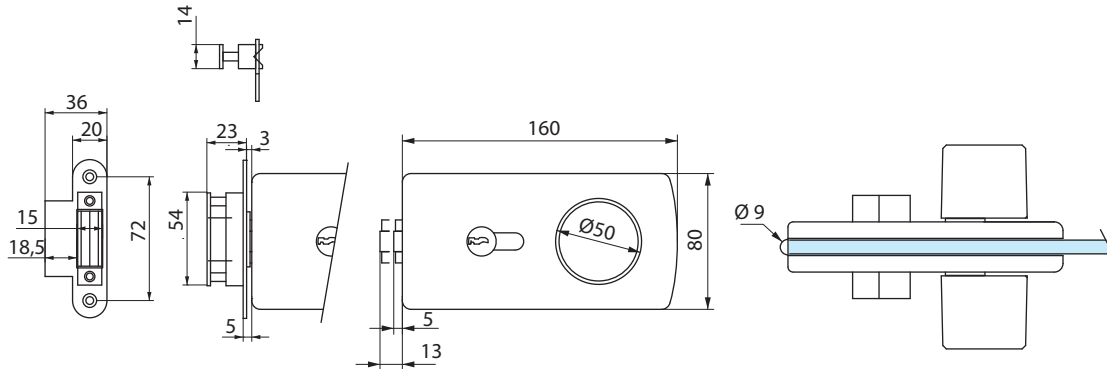
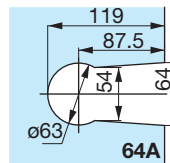

Références / References



Laiton poli
Polished brass



Chromé brillant
Bright chromium



Chromé mat
Matt chromium

Serrure de milieu à cylindre, rouleau et boutons fixes
Lock with euro profile cylinder, roller bolt and fixed knobs

4314.00.0

4314.30.0

4314.31.0

4309.**.1

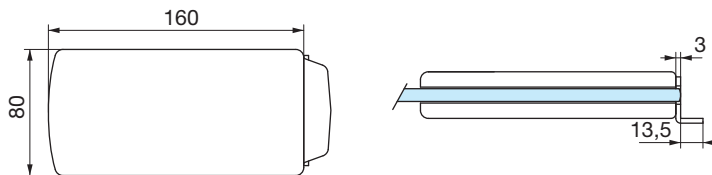
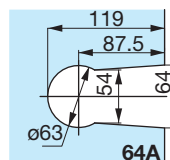

Références / References



Laiton poli
Polished brass



Chromé brillant
Bright chromium



Chromé mat
Matt chromium

Boîtier gâche pour serrure série 4314
Matching patch keep for lock series 4314

4309.00.1

4309.30.1

4309.31.1

4360

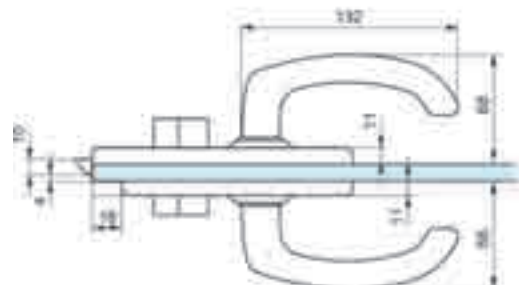
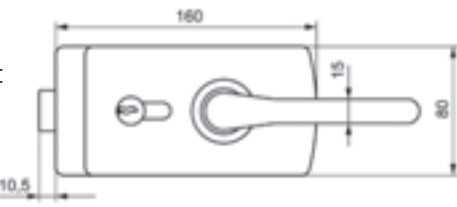
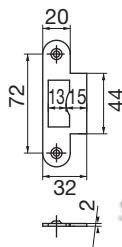
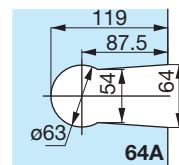

Références / References

Serrure de milieu à cylindre et béquilles avec déport, pêne axé
Lock with euro profile cylinder, handles and offset mechanism



Chromé brillant
Bright chromium



Chromé mat
Matt chromium



Doré
Gold plated



Laqué blanc 9010
Lacquered white RAL 9010



4360.30.0

4360.31.0

4360.40.0

4360.51.0



4360.30.4

4360.31.4

• Le mécanisme déporté permet un contact de la porte en fond de feuillure, et assure la continuité du joint au niveau de la serrure.

• Offset mechanism to allow compression of rebate strip.

4361

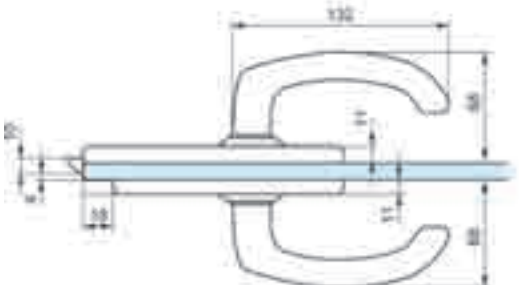
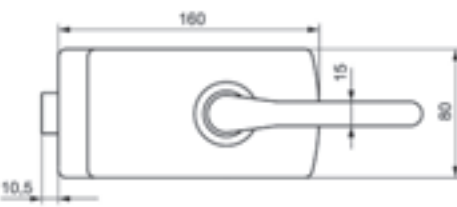
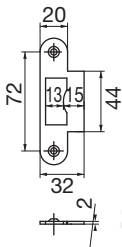
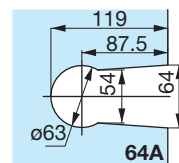

Références / References

Serrure de milieu bec de cane et béquilles avec déport, pêne axé
Latch set with handles and offset mechanism



Chromé brillant
Bright chromium



Chromé mat
Matt chromium



Doré
Gold plated



Laqué blanc 9010
Lacquered white RAL 9010



4361.30.0

4361.31.0

4361.40.0

4361.51.0



4361.30.4

4361.31.4

• Le mécanisme déporté permet un contact de la porte en fond de feuillure, et assure la continuité du joint au niveau de la serrure.

• Offset mechanism to allow compression of rebate strip.

4360.0BT

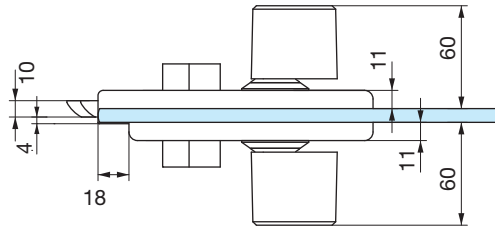
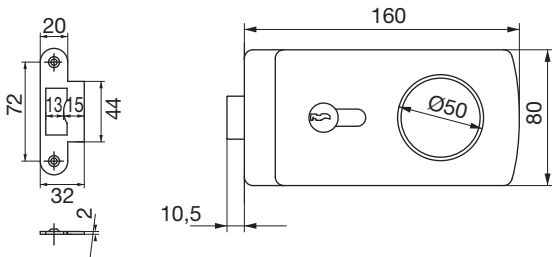
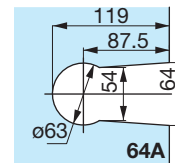

Références / References



Chromé brillant
Bright chromium



Chromé mat
Matt chromium



Laqué blanc 9010
Lacquered white RAL 9010

Serrure de milieu à cylindre et boutons de manoeuvre avec déport, pêne axé
Lock with euro profile cylinder with pair of knobs and offset mechanism

4360.30.0BT

4360.31.0BT

4360.51.0BT

- Le mécanisme déporté permet un contact de la porte en fond de feuillure, et assure la continuité du joint au niveau de la serrure.

- Offset mechanism to allow compression of rebate strip.

4361.0BT

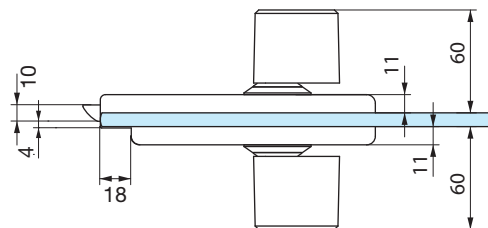
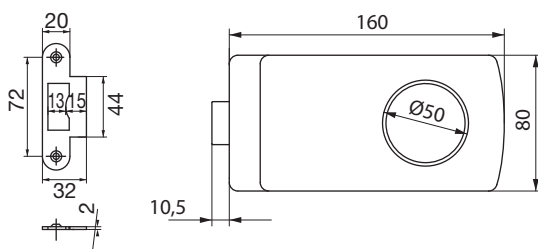
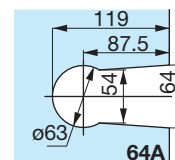

Références / References



Chromé brillant
Bright chromium



Chromé mat
Matt chromium



Laqué blanc 9010
Lacquered white RAL 9010

Serrure de milieu bec de cane avec déport et 2 boutons de manoeuvre
Latch set with knobs and offset mechanism

4361.30.0BT

4361.31.0BT

4361.51.0BT

- Le mécanisme déporté permet un contact de la porte en fond de feuillure, et assure la continuité du joint au niveau de la serrure.

- Offset mechanism to allow compression of rebate strip.

Serrures et
paumelles
Locksets and
hinges

4363.0E*T

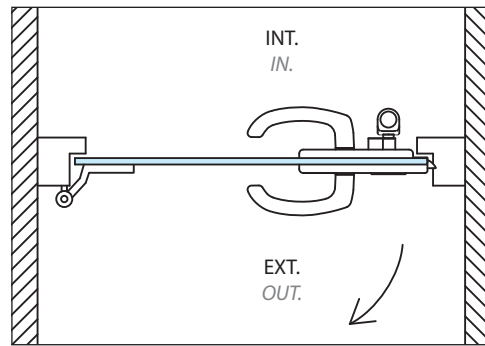
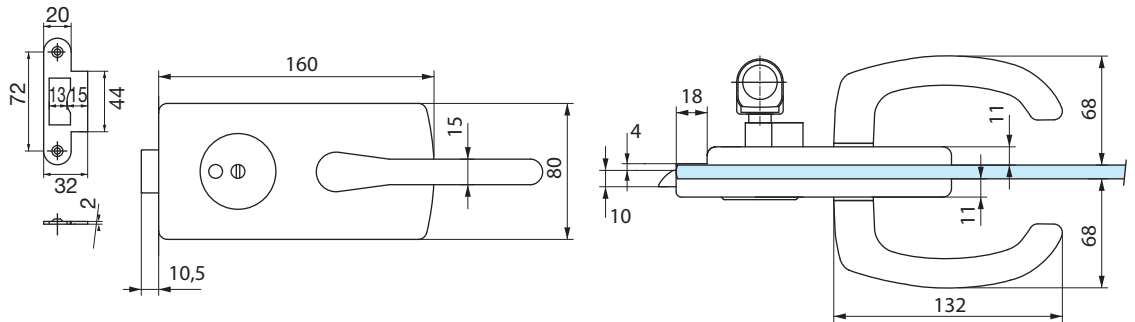
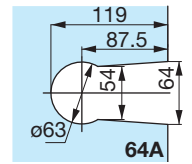

Références / References



Laiton poli
Polished brass



Chromé brillant
Bright chromium



Chromé mat
Matt chromium

Serrure avec voyant ouverture extérieure droite tirant
Lock with colour indicator outside opening right pull

4363.00.0EDT

4363.30.0EDT

4363.31.0EDT

• Le mécanisme déporté permet un contact de la porte en fond de feuillure, et assure la continuité du joint au niveau de la serrure.

• Offset mechanism to allow compression of rebate strip.

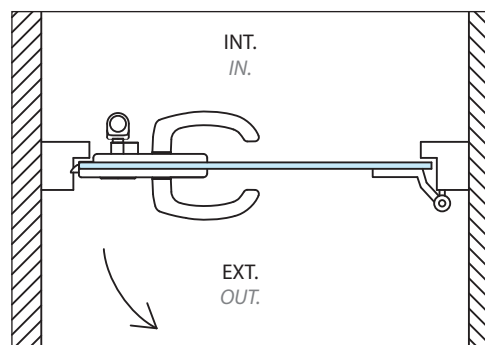

Références / References



Laiton poli
Polished brass



Chromé brillant
Bright chromium



Chromé mat
Matt chromium

Serrure avec voyant ouverture extérieure gauche tirant
Lock with colour indicator outside opening left pull

4363.00.0EGT

4363.30.0EGT

4363.31.0EGT

• Le mécanisme déporté permet un contact de la porte en fond de feuillure, et assure la continuité du joint au niveau de la serrure.

• Offset mechanism to allow compression of rebate strip.

LES + PRODUITS

Mécanisme déporté

Idéal pour cabine et vestiaire

Sécurité : décondamnation d'urgence

Offset mechanism

Ideal for toilets and cloakrooms

Security : emergency exit

4363.01*P

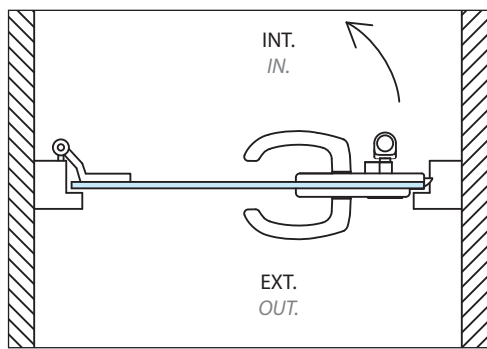
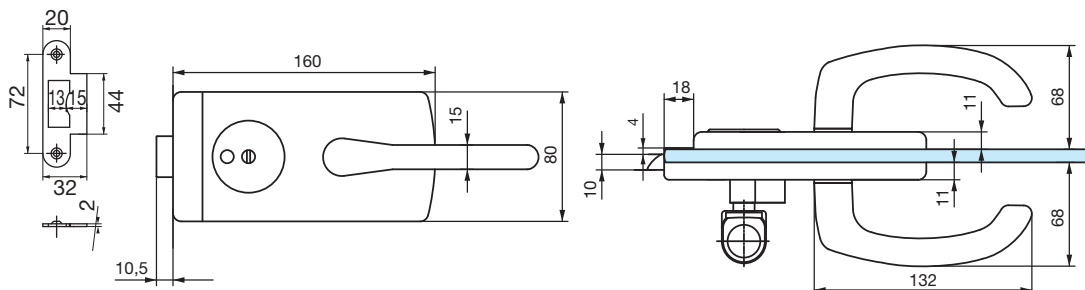
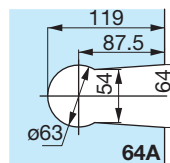

Références / References



Laiton poli
Polished brass



Chromé brillant
Bright chromium



Chromé mat
Matt chromium

Serrure avec voyant ouverture intérieure droite poussant
Lock with colour indicator inside opening right push

4363.00.0IDP

4363.30.0IDP

4363.31.0IDP

- Le mécanisme déporté permet un contact de la porte en fond de feuillure, et assure la continuité du joint au niveau de la serrure.

- Offset mechanism to allow compression of rebate strip.

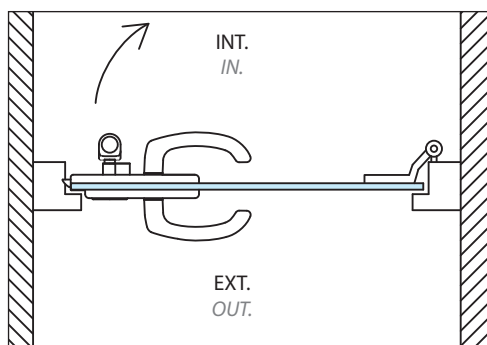

Références / References



Laiton poli
Polished brass



Chromé brillant
Bright chromium



Chromé mat
Matt chromium

Serrure avec voyant ouverture intérieure gauche poussant
Lock with colour indicator inside opening left push

4363.00.0IGP

4363.30.0IGP

4363.31.0IGP

- Le mécanisme déporté permet un contact de la porte en fond de feuillure, et assure la continuité du joint au niveau de la serrure.

- Offset mechanism to allow compression of rebate strip.

4367.0**

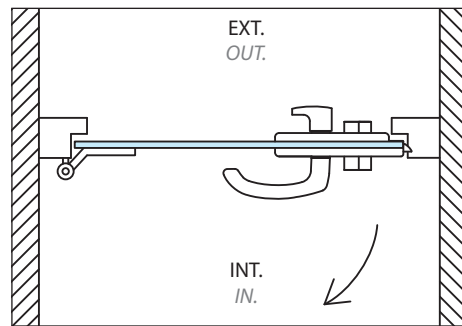
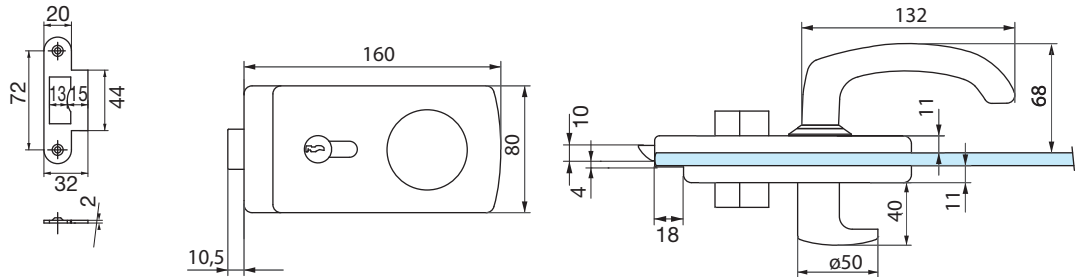
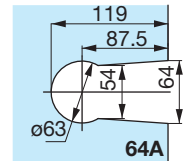

LES + PRODUITS

Mécanisme
déporté

Offset mechanism

Références / References



Serrure de milieu à cylindre et déport avec béquille intérieure
et bouton fixe extérieur, condamnation sans avancement du pêne
*Lock with euro profile cylinder and offset with handle inside
fixed knob outside, without forward latch bolt motion*

- Le mécanisme déporté permet un contact de la porte en fond de feuillure, et assure la continuité du joint au niveau de la serrure.



Chromé brillant
Bright chromium



Chromé mat
Matt chromium

4367.30.0AD

4367.31.0AD

- Offset mechanism to allow compression of rebate strip.

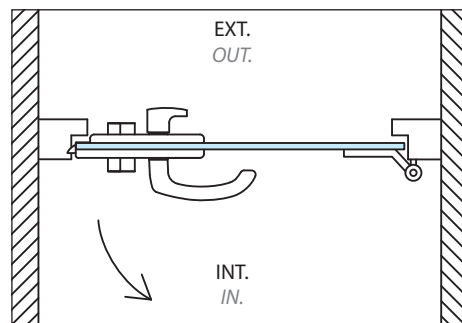

Références / References



Serrure de milieu à cylindre et déport avec béquille intérieure
et bouton fixe extérieur, condamnation sans avancement du pêne
*Lock with euro profile cylinder and offset with handle inside
fixed knob outside, without forward latch bolt motion*

- Le mécanisme déporté permet un contact de la porte en fond de feuillure, et assure la continuité du joint au niveau de la serrure.



Chromé brillant
Bright chromium



Chromé mat
Matt chromium

4367.30.0BC

4367.31.0BC

- Offset mechanism to allow compression of rebate strip.

4366

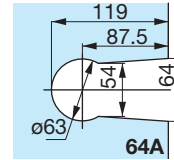

Serrures et
paumelles
Locksets and
hinges

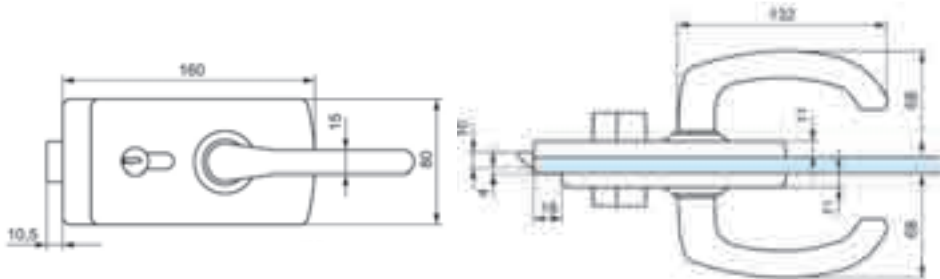
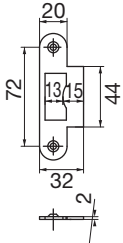

Références / References



Chromé brillant
Bright chromium



Chromé mat
Matt chromium

Serrure de milieu à barillet et béquilles avec déport, condamnation sans avancement de pêne
Lock with euro profile cylinder offset and handles without forward motion of latch bolt

4366.30.0

4366.31.0

• Le mécanisme déporté permet un contact de la porte en fond de feuillure, et assure la continuité du joint au niveau de la serrure.

• Offset mechanism to allow compression of rebate strip.



Nombreuses versions
Large variety of models

4380

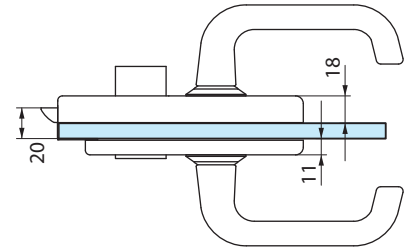
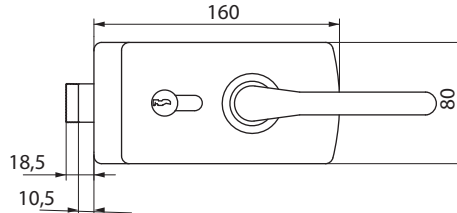
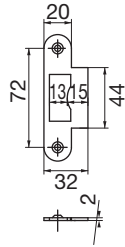
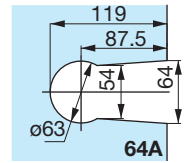

Références / References

Serrure de milieu à cylindre et béquilles avec déport, pêne désaxé,
condamnation sans avancement de pêne
Lock set with handles, offset mechanism and spring bolt
without forward motion of latch bolt



Chromé brillant
Bright chromium



Chromé mat
Matt chromium



Laqué blanc 9010
Lacquered white RAL 9010



4380.30.0

4380.31.0

4380.51.0



4380.31.4

- Le mécanisme déporté permet un contact de la porte en fond de feuillure, et assure la continuité du joint au niveau de la serrure.

- Offset mechanism to allow compression of rebate strip.

4381

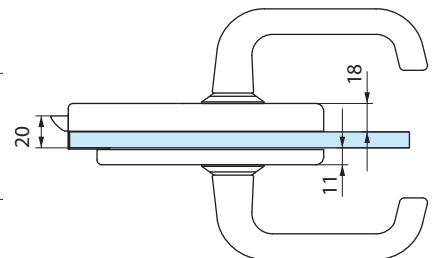
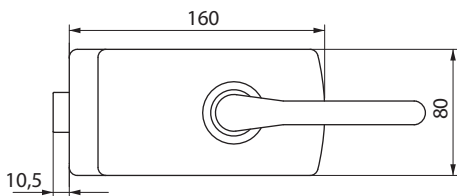
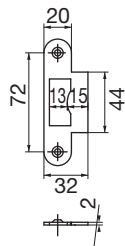
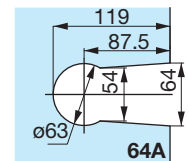

Références / References

Serrure de milieu bec de cane et béquilles avec déport, pêne désaxé,
condamnation sans avancement de pêne
Latch with euro profile cylinder with handles, offset mechanism and spring bolt,
without forward motion of latch bolt



Chromé brillant
Bright chromium



Chromé mat
Matt chromium



Laqué blanc 9010
Lacquered white RAL 9010



4381.30.0

4381.31.0

4381.51.0

- Le mécanisme déporté permet un contact de la porte en fond de feuillure, et assure la continuité du joint au niveau de la serrure.

- Offset mechanism to allow compression of rebate strip.

4389

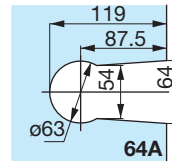

Serrures et
paumelles
Locksets and
hinges

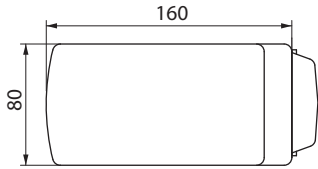

Références / References



Chromé brillant
Bright chromium

4389.30.0



Chromé mat
Matt chromium

4389.31.0



Laqué blanc 9010
Lacquered white RAL 9010

4389.51.0

Boîtier gâche pour serrures série 4380
Matching patch keep for locks series 4380



BASTILLE

Caractéristiques techniques

- Pour verre trempé de 8 – 10 et 12 mm
- Montage sur encoche 6300EX
- Réversible
- A cylindre européen panneton DIN (norme DIN 18254)
- Avec caches cylindre
- Rappel du pêne à la clé
- Condamnation avec avancement du pêne
- Possibilités de combinaison avec passe général
- Livrée avec gâche plate et 3 clés

Technical features

- For 8 -10 and 12 mm thick toughened glass
- To fit notch 6300EX
- Reversible
- European profile cylinder (DIN standard 18254)
- With cylinder covers
- Return of the latch bolt by key
- Locked with forward motion of latch bolt
- Possibility of combinations with master key
- Supplied with flat keep and 3 keys

- **Le mécanisme déporté permet un contact de la porte en fond de feuillure, et assure la continuité du joint au niveau de la serrure.**

- **Offset mechanism to allow compression of rebate strip.**

LES + PRODUITS

The + product

Design épuré

Certifié TUV

Grande qualité
de finition

Mécanisme
de précision

Réversible

Refined design

TUV certified

High quality finishes

Precision mechanics

Reversible



4501

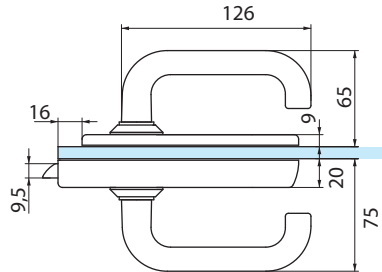
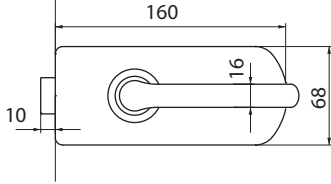
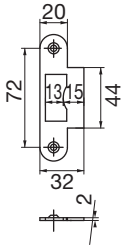
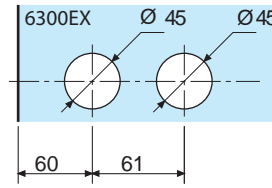

Références / References



Laiton poli PVD
Polished brass PVD



Chromé brillant
Bright chromium



Chromé mat
Matt chromium



Effet inox
Stainless steel effect



Laqué blanc 9010
Lacquered white RAL 9010

Serrure de milieu bec de cane et béquilles
Latch set with pair of handles

4501.05.0

4501.30.0

4501.31.0

4501.35.0

4501.51.0

4550.**.*

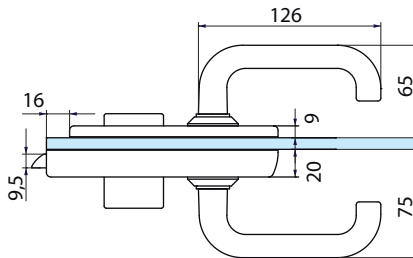
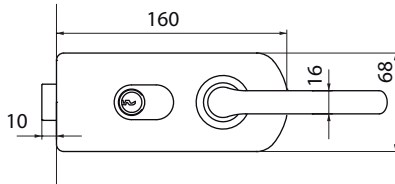
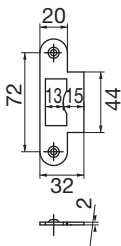
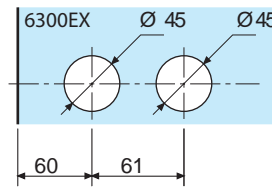

Références / References

Serrure de milieu à cylindre et double béquilles, caches cylindre
Lock with euro profile cylinder, pair of handles and cylinder cover



Laiton poli PVD
Polished brass PVD



Chromé brillant
Bright chromium



Chromé mat
Matt chromium



Effet inox
Stainless steel effect



Laqué blanc 9010
Lacquered white RAL 9010



4550.05.0

4550.30.0

4550.31.0

4550.35.0

4550.51.0



4550.05.4

4550.30.4

4550.31.4

4550.35.4

4550.51.4



4550.05.5

4550.30.5

4550.31.5

4550.35.5

4550.51.5

Serrures et paumelles
Locksets and hinges

4555.**.0

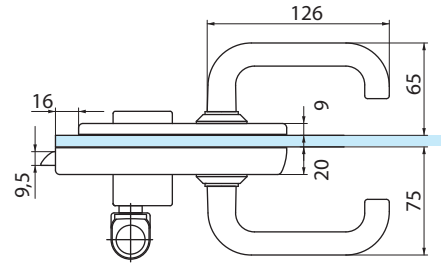
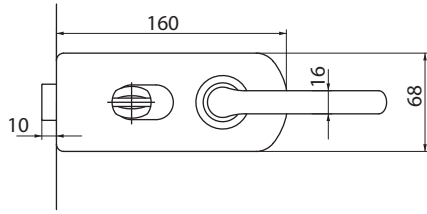
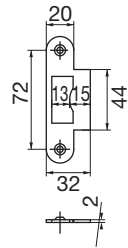
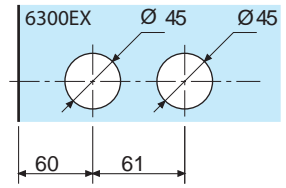

Références / References

Serrure de milieu avec cylindre à bouton et double béquilles, caches cylindre
Lock with thumb turn cylinder, pair of handles and cylinder cover

Laiton poli PVD Polished brass PVD	Chromé brillant Bright chromium	Chromé mat Matt chromium	Effet inox Stainless steel effect	Laqué blanc 9010 Lacquered white RAL 9010



4555.05.0

4555.30.0

4555.31.0

4555.35.0

4555.51.0



4555.05.4

4555.30.4

4555.31.4

4555.35.4

4555.51.4



4555.05.5

4555.30.5

4555.31.5

4555.35.5

4555.51.5

4509

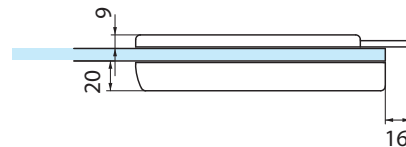
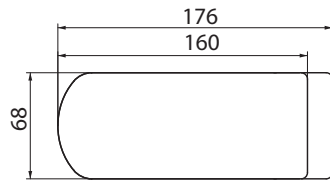
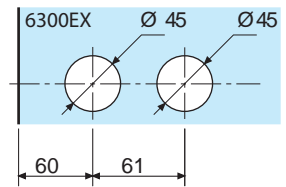

Références / References



Laiton poli PVD Polished brass PVD	Chromé brillant Bright chromium	Chromé mat Matt chromium	Effet inox Stainless steel effect	Laqué blanc 9010 Lacquered white RAL 9010

Boîtier gâche pour serrures série 4500
Matching patch keep for locks series 4500

4509.05.0

4509.30.0

4509.31.0

4509.35.0

4509.51.0



LUMIRA HORIZONTALE

Caractéristiques techniques

- Pour verre trempé de 8, 10 et 12 mm
- Montage sur encoche 6300EX
- Réversible
- Condamnation par clé avec avancement du pêne.
- Rappel du pêne tour à la clé

Technical features

- For 8- 10 and 12 mm thick toughened glass
- To fit notch 6300EX
- Reversible
- Locked by key with forward motion of latch bolt
- Retractable latch bolt by key.

LES + PRODUITS

The + product

Mécanisme
déporté

Résistance à l'usage
intensif

Nombreuses
versions

Offset mechanism

Resistance
to heavy use

Large variety
of models

V525

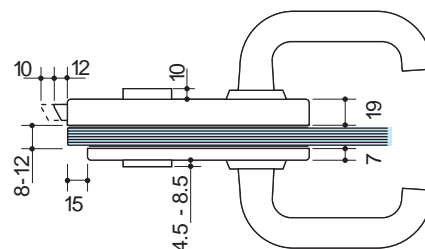
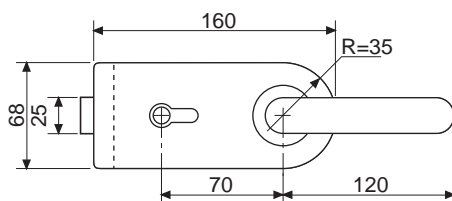
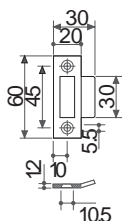
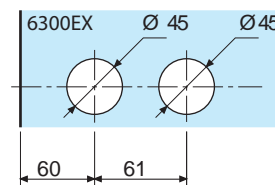

Références / References



Serrure de milieu avec cylindre Européen
avec béquilles
Lock with euro profile cylinder and handles



Laiton poli verni
Polished varnished brass

V525.01



Aluminium anodisé Argent Brossé
Brushed anodised alu silver

V525.12



Chromé brillant
Bright chromium

V525.30



Chromé mat brossé
Brushed matt chromium

V525.33

- Le mécanisme déporté permet un contact de la porte en fond de feuillure, et assure la continuité du joint au niveau de la serrure.

- Offset mechanism to allow compression of rebate strip.

V525.2.**

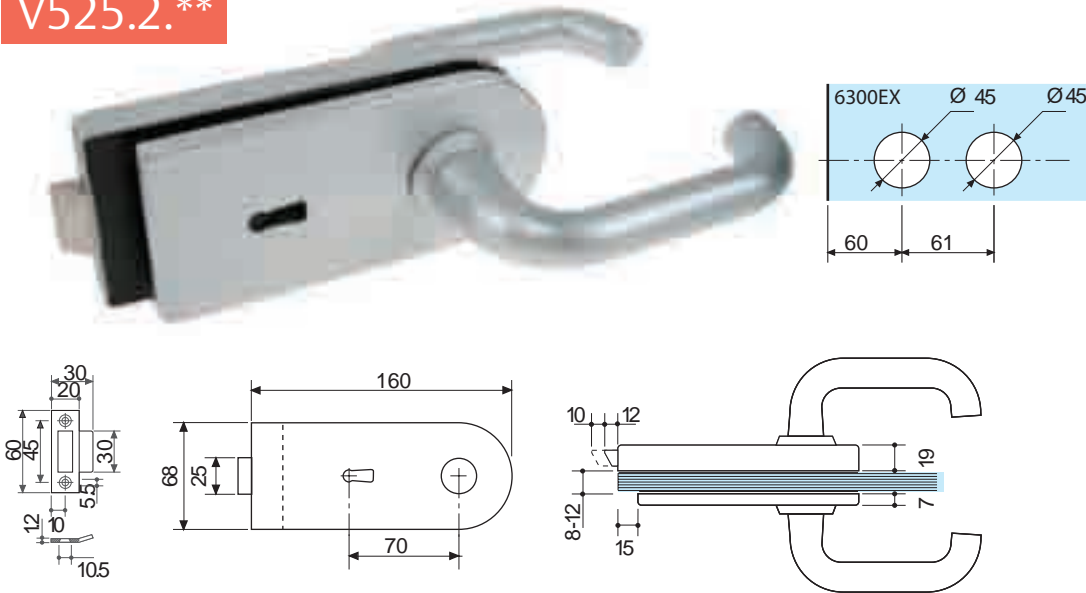

Références / References



Laiton poli verni
Polished varnished brass



Aluminium anodisé Argent Brossé
Brushed anodised alu silver



Chromé brillant
Bright chromium



Chromé mat brossé
Brushed matt chromium

Serrure de milieu avec clé à panneton avec béquille.
Lock with one bb-key and handles.

V525.2.01

V525.2.12

V525.2.30

V525.2.33

- Le mécanisme déporté permet un contact de la porte en fond de feuillure, et assure la continuité du joint au niveau de la serrure.

- Offset mechanism to allow compression of rebate strip.

V526

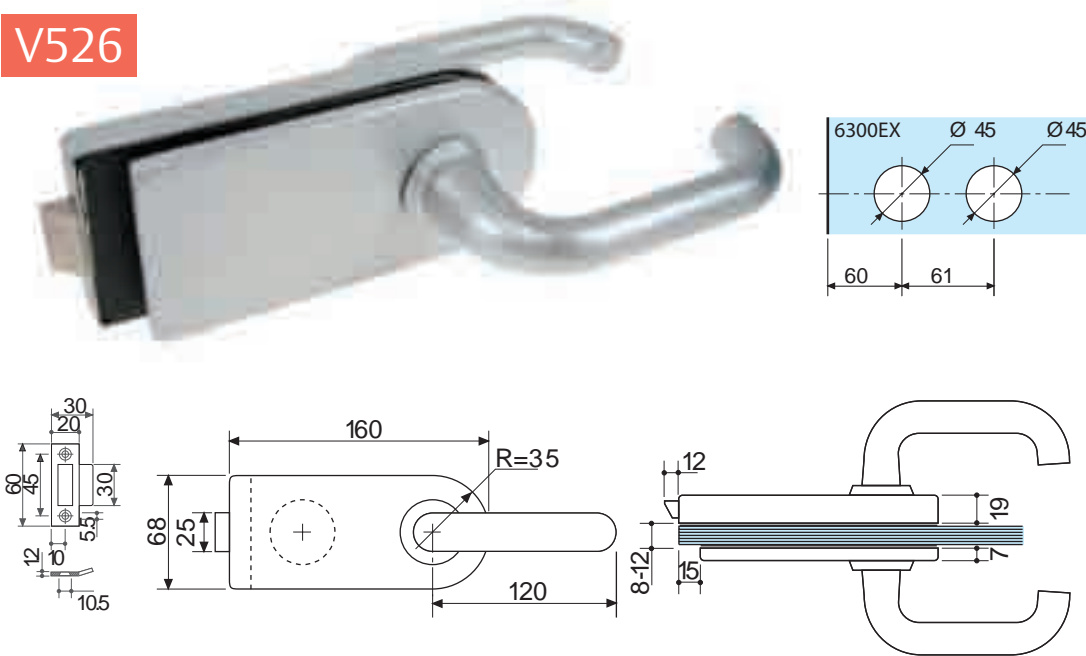

Références / References



Laiton poli verni
Polished varnished brass



Aluminium anodisé Argent Brossé
Brushed anodised alu silver



Chromé brillant
Bright chromium



Chromé mat brossé
Brushed matt chromium

Serrure de milieu avec béquille
Latch set with handles

V526.01

V526.12

V526.30

V526.33

- Le mécanisme déporté permet un contact de la porte en fond de feuillure, et assure la continuité du joint au niveau de la serrure.

- Offset mechanism to allow compression of rebate strip.

V350

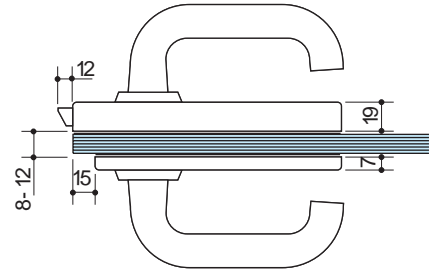
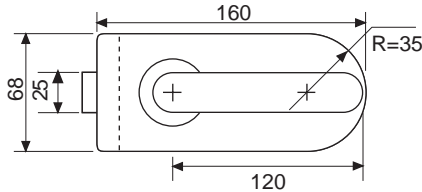
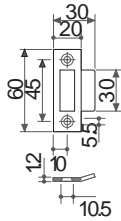
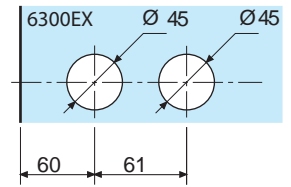

Références / References



Serrure de milieu avec béquilles
Latch set with handles



Laiton poli verni
Polished varnished brass



Aluminium anodisé Argent Brossé
Brushed anodised alu silver



Chromé brillant
Bright chromium



Chromé mat brossé
Brushed matt chromium

V350.01

V350.12

V350.30

V350.33

- Le mécanisme déporté permet un contact de la porte en fond de feuillure, et assure la continuité du joint au niveau de la serrure.

- Offset mechanism to allow compression of rebate strip.

V310

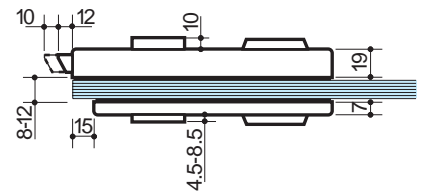
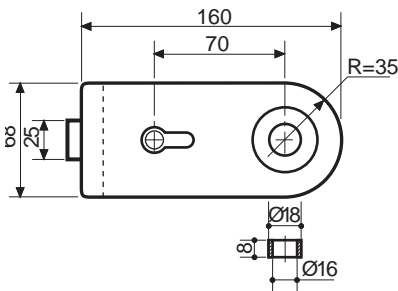
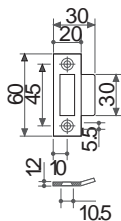
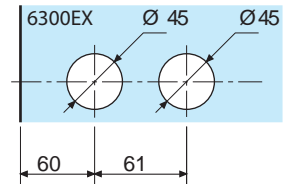

Références / References



Serrure de milieu sans cylindre (V017) et pour bouton ou double béquilles
Lock without cylinder (V017) and pair of handles or knobs



Laiton poli verni
Polished varnished brass



Aluminium anodisé Argent Brossé
Brushed anodised alu silver



Inox Brossé
Brushed stainless steel



Chromé brillant
Bright chromium



Chromé mat brossé
Brushed matt chromium



Aluminium anodisé Aninox
Brushed anodised alu.

V310.01

V310.12

V310.15

V310.30

V310.33

V310.36

- Le mécanisme déporté permet un contact de la porte en fond de feuillure, et assure la continuité du joint au niveau de la serrure.

- Offset mechanism to allow compression of rebate strip.

V320

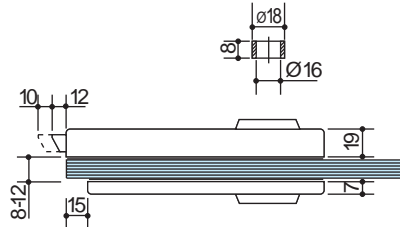
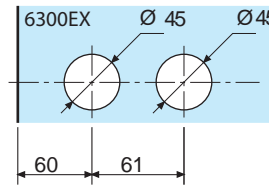
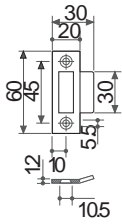

Serrures et paumelles
Locksets and hinges

Références / References



Serrure de milieu avec clé à panneton sans béquille
Lock with one bb-key without handles



Laiton poli verni
Polished varnished brass

V320.01



Aluminium anodisé Argent Brossé
Brushed anodised alu silver

V320.12



Inox Brossé
Brushed stainless steel

V320.15



Chromé brillant
Bright chromium

V320.30



Chromé mat brossé
Brushed matt chromium

V320.33



Aluminium anodisé Aninox
Brushed anodised alu.

V320.36

• Le mécanisme déporté permet un contact de la porte en fond de feuillure, et assure la continuité du joint au niveau de la serrure.

• Offset mechanism to allow compression of rebate strip.

V330

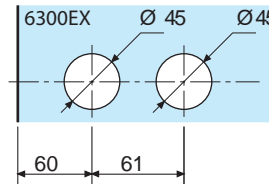
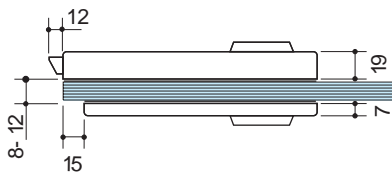
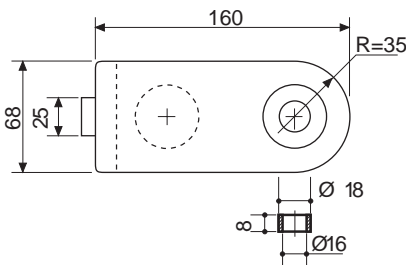
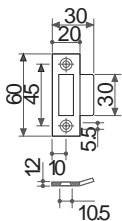

Références / References



Serrure de milieu sans béquille
Latch set without handles



Laiton poli verni
Polished varnished brass

V330.01



Aluminium anodisé Argent Brossé
Brushed anodised alu silver

V330.12



Inox Brossé
Brushed stainless steel

V330.15



Chromé brillant
Bright chromium

V330.30



Chromé mat brossé
Brushed matt chromium

V330.33



Aluminium anodisé Aninox
Brushed anodised alu.

V330.36

• Le mécanisme déporté permet un contact de la porte en fond de feuillure, et assure la continuité du joint au niveau de la serrure.

• Offset mechanism to allow compression of rebate strip.

V340

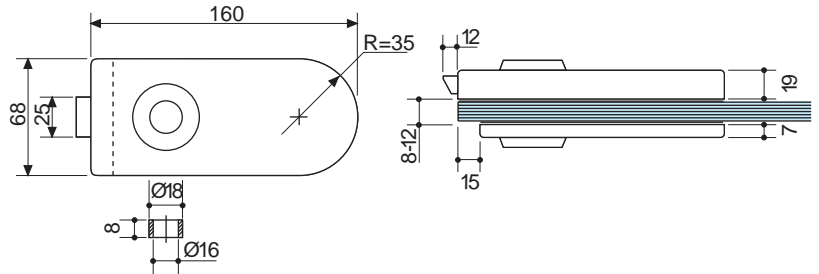
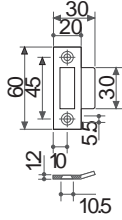
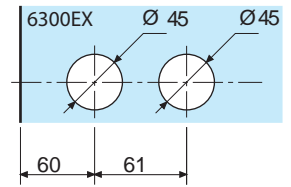

Références / References



Serrure de milieu sans béquille
Latch set without handles



Laiton poli verni
Polished varnished brass

V340.01



Aluminium anodisé Argent Brossé
Brushed anodised alu silver

V340.12



Inox Brossé
Brushed stainless steel

V340.15



Chromé brillant
Bright chromium

V340.30



Chromé mat brossé
Brushed matt chromium

V340.33



Aluminium anodisé Aninox
Brushed anodised alu.

V340.36

- Le mécanisme déporté permet un contact de la porte en fond de feuillure, et assure la continuité du joint au niveau de la serrure.

- Offset mechanism to allow compression of rebate strip.

V527

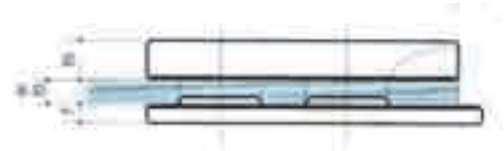
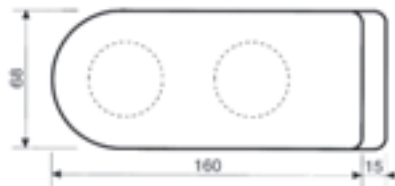
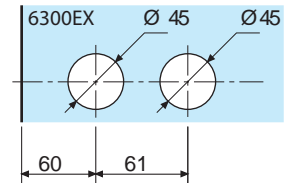

Références / References



Boîtier Gâche pour serrure de milieu série Lumira horizontale.
Matching patch keep for lock series Lumira horizontal



Laiton poli verni
Polished varnished brass

V527.01



Aluminium anodisé Argent Brossé
Brushed anodised alu silver

V527.12



Inox Brossé
Brushed stainless steel

V527.15



Chromé brillant
Bright chromium

V527.30



Chromé mat brossé
Brushed matt chromium

V527.33



Aluminium anodisé Aninox
Brushed anodised alu.

V527.36



V750

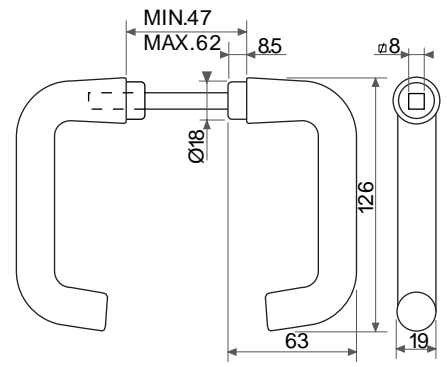

Références / References

Laiton poli verni
Polished varnished brass

Aluminium anodisé Argent Brossé
Brushed anodised alu silver

Inox Brossé
Brushed stainless steel

Chromé brillant
Bright chromium

Chromé mat brossé
Brushed matt chromium

Paire de béquilles forme ronde
pour V310, V320, V330 et V340
Pair of lever handles rounded design
for V310, V320, V330 and V340

V750.01

V750.12

V750.15

V750.30

V750.33



V760

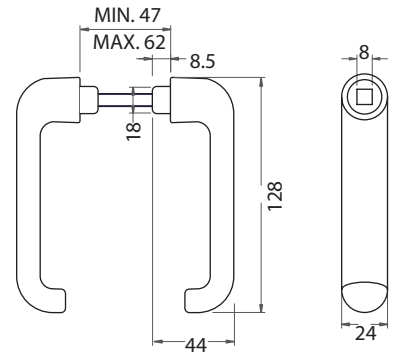

Aluminium anodisé Argent Brossé
Brushed anodised alu silver

Références / References

Paire de béquilles forme plate pour V310, V320, V330 et V340
Pair of lever handles flat design for V310, V320, V330 and V340

V760.12

V525.5.**

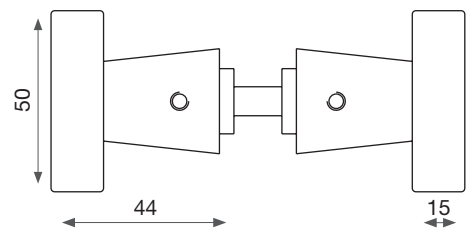

Laiton poli verni
Polished varnished brass

Aluminium anodisé Argent Brossé
Brushed anodised alu silver

Références / References

Paire de boutons pour V310, V320, V330 et V340
Pair of door knobs for V310, V320, V330 and V340

V525.5.01

V525.5.12

V554.2

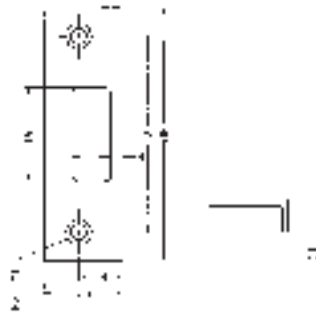

Laiton poli verni
Polished varnished brass



Inox Brossé
Brushed stainless steel

Références / References

Gâche pour V310, V320, V330 et V340 type allemand
Keep plate for V310, V320, V330 and V340 german style

V554.2.01

V554.2.15

V533.1

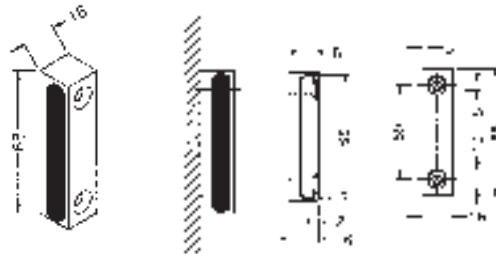

Laiton poli verni
Polished varnished brass



Aluminium anodisé Argent Brossé
Brushed anodised alu silver



Chromé brillant
Bright chromium



Chromé mat brossé
Brushed matt chromium



Aluminium anodisé Aninox
Brushed anodised alu.

Références / References

Butée pour serrure de milieu
Wall stop for locks

V533.1.01

V533.1.12

V533.1.30

V533.1.33

V533.1.36

V017

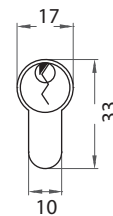
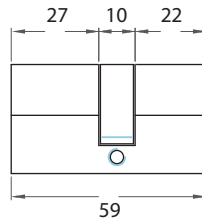

Laiton poli verni
Polished varnished brass



Chromé brillant
Bright chromium

Références / References



Cylindre Européen 59 mm
Europrofile cylinder 59 mm

V017.01

V017.30

LUMIRA VERTICALE

Caractéristiques techniques

- Pour verre trempé de 8, 10 et 12 mm
- Montage sur encoche V370E
- Avec pêne demi tour et pêne dormant

Technical features

- For 8-10 and 12 mm thick toughened glass
- To fit notch V370E
- With spring and dead bolt



LES + PRODUITS

The + product

Grande qualité
de finition

Résistance à l'usage
intensif

Sécurité accrue

High quality finishes

Resistance
to heavy use

Increased security

V360

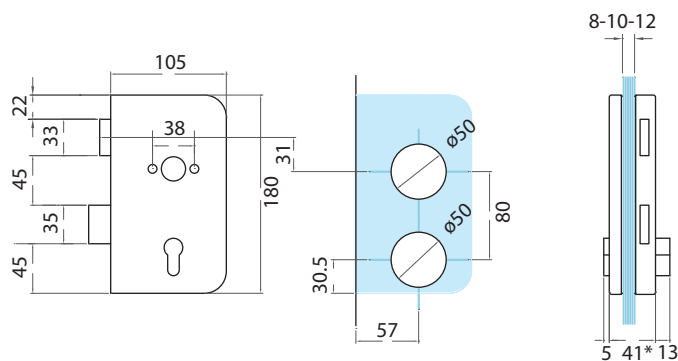
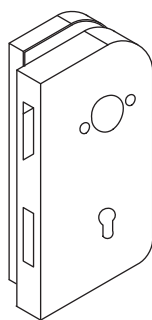

*=10mm

Références / References



Serrure de milieu pour cylindre Européen sans béquille, DIN droite
Lock for Euro profile cylinder without handles DIN right

Aluminium anodisé Argent Brossé
Brushed anodised alu silver

Inox Brossé
Brushed stainless steel

V360.12

V360.15

V370

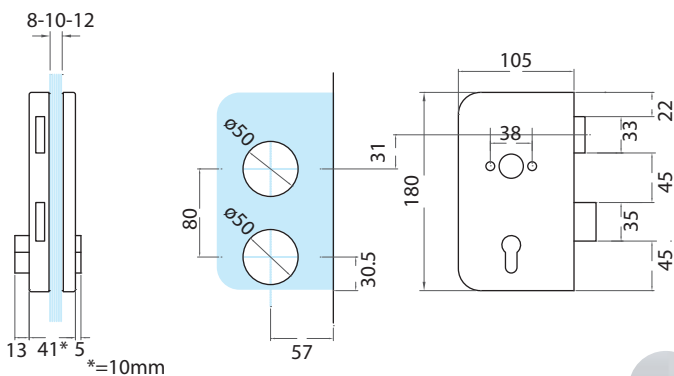
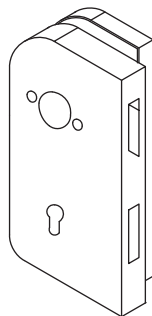

Références / References



Serrure de milieu pour cylindre Européen sans béquille, DIN gauche
 Lock for Euro profile cylinder without handles DIN left



Aluminium anodisé Argent Brossé
 Brushed anodised alu silver

V370.12



Inox Brossé
 Brushed stainless steel

V370.15

V361

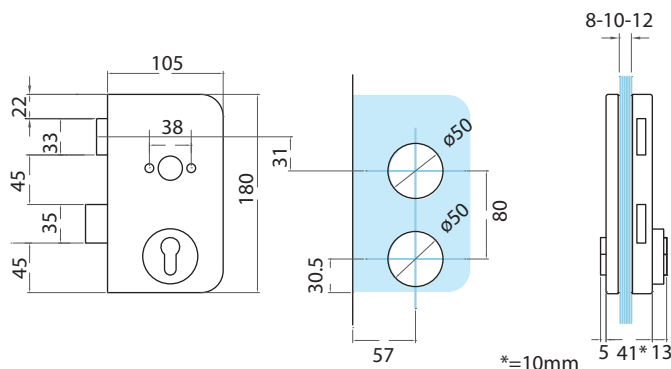
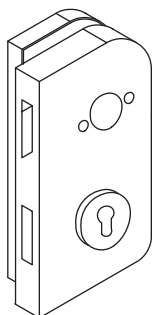

Références / References



Serrure de milieu pour cylindre Européen sans béquille, avec cache cylindre DIN droite
 Lock for Euro profile cylinder without handles, with cylinder cover DIN right



Aluminium anodisé Argent Brossé
 Brushed anodised alu silver

V361.12



Inox Brossé
 Brushed stainless steel

V361.15

V371

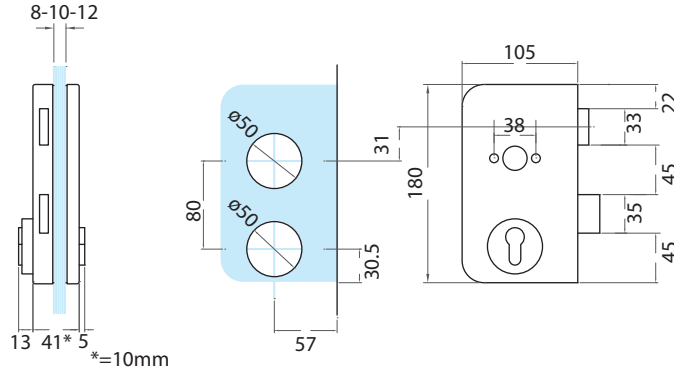
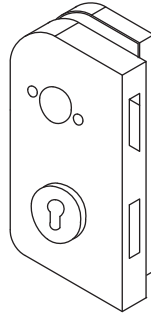

Références / References



Serrure de milieu pour cylindre Européen sans béquille, avec cache cylindre DIN gauche
Lock for Euro profile cylinder without handles, with cylinder cover DIN left



V371.12

V371.15

V367

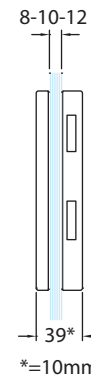
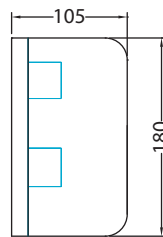
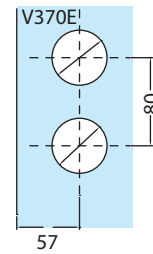
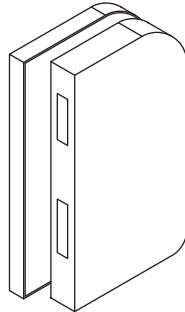

Références / References



Boîtier gâche pour serrure de milieu pour V370, V371 / DIN droite
Matching patch keep for lock V370, V371 / DIN right



V367.12

V367.15

V377

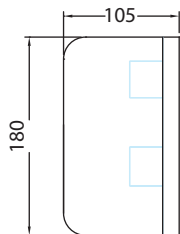
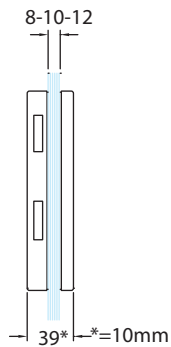
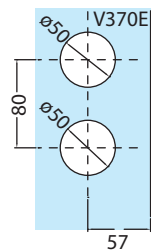
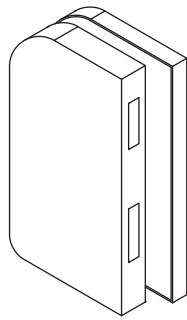

Références / References



Boîtier gâche pour serrure de milieu pour V360, V361 / DIN gauche
 Matching patch keep for centre lock V360, V361 / DIN left



Aluminium anodisé Argent Brossé
 Brushed anodised alu silver

V377.12



Inox Brossé
 Brushed stainless steel

V377.15

V770

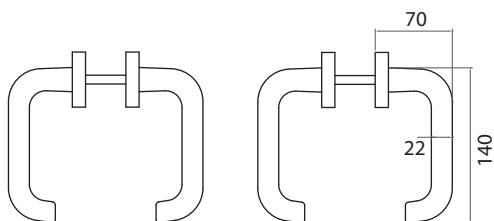

Références / References

Paire de béquilles avec rosace pour V360, V361, V370 et V371
 Pair of lever handles with rosettes for V360, V361, V370, and V371



Aluminium anodisé Argent Brossé
 Brushed anodised alu silver

V770.12



Inox Brossé
 Brushed stainless steel

V770.15

Serrures et
 paumelles
 Locksets and
 hinges

V780

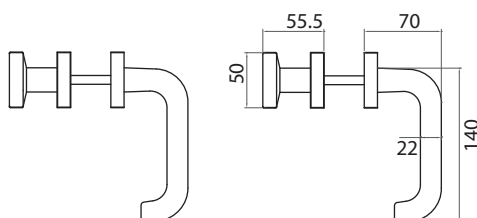

Aluminium anodisé Argent Brossé
Brushed anodised alu silver



Inox Brossé
Brushed stainless steel

Références / References

Bouton fixe / béquille pour V360, V361, V370 et V371
Combination fixed knob / lever handle for V360, V361, V370 and V371

V780.12

V780.15

V533.1

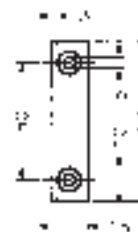

Laiton poli verni
Polished varnished brass



Aluminium anodisé Argent Brossé
Brushed anodised alu silver



Chromé brillant
Bright chromium



Chromé mat brossé
Brushed matt chromium



Aluminium anodisé Aninox
Brushed anodised alu.

Références / References

Butée pour serrure de milieu
Wall stop for lock

V533.1.01

V533.1.12

V533.1.30

V533.1.33

V533.1.36

V2140

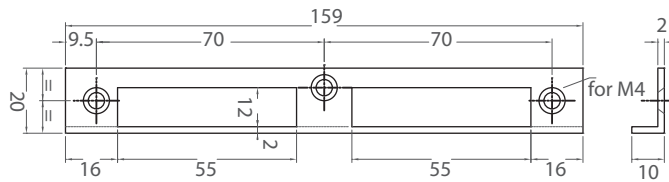

Inox Brossé
Brushed stainless steel

Références / References

Gâche forme L pour V360, V361, V370 et V371
Keep plate L shape for V360, V361, V370, and V371

V2140.15

V2140.2

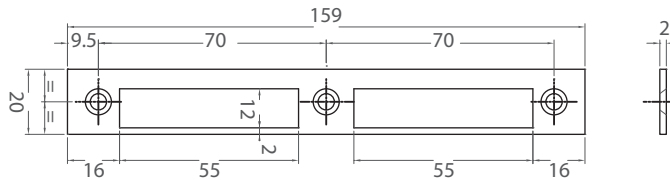

Inox Brossé
Brushed stainless steel

Références / References

Gâche pour V360, V361, V370 et V371
Keep plate for V360, V361, V370 and V371

V2140.2.15

V017

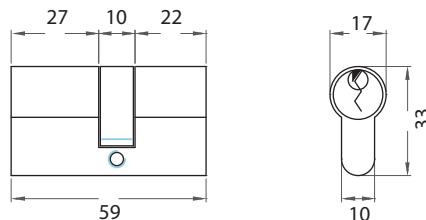

Laiton poli verni
Polished varnished brass



Chromé brillant
Bright chromium

Références / References



Cylindre Européen 59 mm
Europrofile cylinder 59 mm

V017.01

V017.30

CLASSIC



Caractéristiques techniques

- Pour verre trempé de 8, 10 mm
- Montage sur encoche 64A avec cale d'encoche et sur les anciennes encoches 60A, 60B, 64
- Réversible par retournement du pêne demi-tour pour adaptation selon sens d'ouverture de la porte
- Pêne demi tour et pêne dormant indépendants
- A cylindres avec protection par bagues tournantes
- Rappel du demi-tour à la clé
- Livré avec gâche plate, 3 clés et cale d'encoche

Technical features

- For 8 and 10 mm thick toughened glass
- To fit notch 64A with notch wedge supplied and on notches 60A, 60B and 64
- Reversible by altering latch bolt to adapt to the opening direction of the door
- Individual latch and dead bolt
- Protected cylinder
- Return of latch bolt with moring collar
- Supplied with flat keep, 3 keys and notch wedge

LES + PRODUITS

The + product

Grande qualité
de finition

Compatible
anciennes encoches

Sécurité :
pêne dormant
indépendant

High quality finishes

Compatible with long
standing notches

Security :
independant bolt

1300

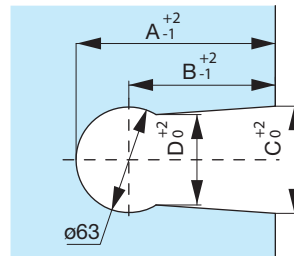

Encoche	A	B	C	D
60A	94,5	62	62	51
60B	94,5	63	65	57
64	110	78,5	65	54
64A	119	87,5	64	54

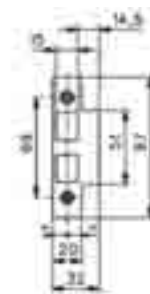
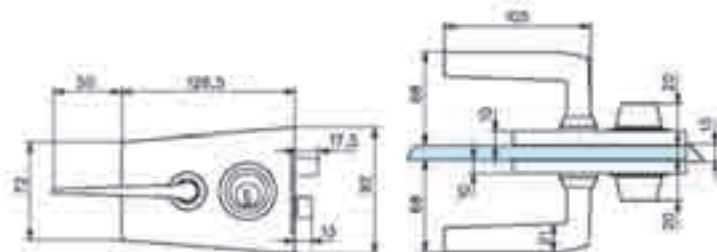

Références / References



Laiton poli
Polished brass



Chromé brillant
Bright chromium



Chromé mat
Matt chromium

Serrure de milieu à cylindre et double béquilles
Lock with euro profile cylinder and double handles

1300.00.0

1300.30.0

1300.31.0

1301

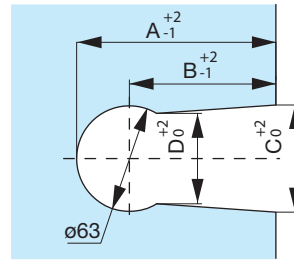

Encoche	A	B	C	D
60A	94,5	62	62	51
60B	94,5	63	65	57
64	110	78,5	65	54
64A	119	87,5	64	54

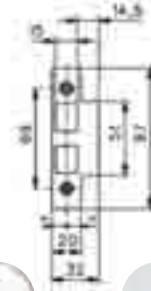
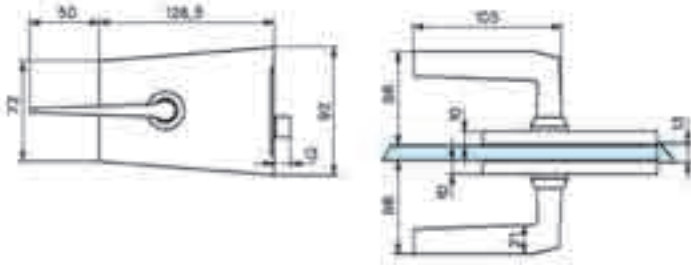

Références / References



Laiton poli
Polished brass



Chromé brillant
Bright chromium



Chromé mat
Matt chromium

Serrure de milieu bec de cane et double béquilles
Latch set with double handles

1301.00.0

1301.30.0

1301.31.0

1309

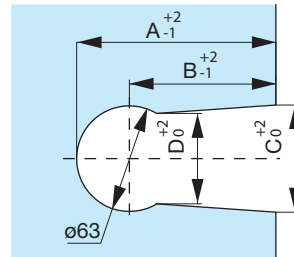

Encoche	A	B	C	D
60A	94,5	62	62	51
60B	94,5	63	65	57
64	110	78,5	65	54
64A	119	87,5	64	54

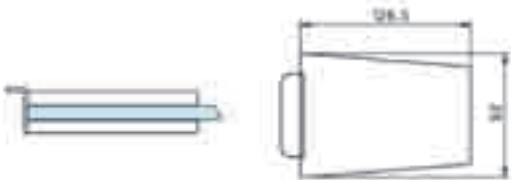

Références / References



Laiton poli
Polished brass



Chromé brillant
Bright chromium



Chromé mat
Matt chromium

Boîtier gâche pour serrures série 1300
Matching patch keep for locks series 1300

1309.00.0

1309.30.0

1309.31.0

Serrures et
paumelles
Locksets and
hinges

DOORFRAME

Caractéristiques techniques

- Pour porte en verre trempé de 8, 10 et 12 mm
- Pour panneaux fixe de 8, 10, 12 et 15 mm
- Profil permettant d'appliquer différentes charnières
- Compatible avec les serrures séries LUMIRA, LUMIRA vertical, BASTILLE, LAGUNE
- Le galet de blocage RS02 peut être installé avec une paire de poignées ou une paire de boutons
- Possibilité d'intégration d'une gâche électrique (voir chapitre contrôle d'accès)
- Permet l'intégration facile d'une porte en verre dans un ensemble Sécurité
- Utilisation des profils KL001 et KL002 recommandé pour fixation de l'ensemble

Technical features

- For doors of 8, 10 and 12 mm. thick toughened glass
- For fixed panels of 8, 10, 12 and 15 mm
- Profile allowing several different hinges
- Compatible with lock series LUMIRA, LUMIRA vertical, BASTILLE, LAGUNE
- A blocking roller keep can be installed so handles or door knobs can be used
- Possible installation of an electric release keep (see chapter access control)
- Allows an easy integration of a glass door in a Securit set
- Use KL001 and KL002 profiles recommended to fix the frames

LES + PRODUITS

The + product

Esthétique

Étanchéité
acoustique

Installation facile

Elegant design

Sound proofed

Easy installation

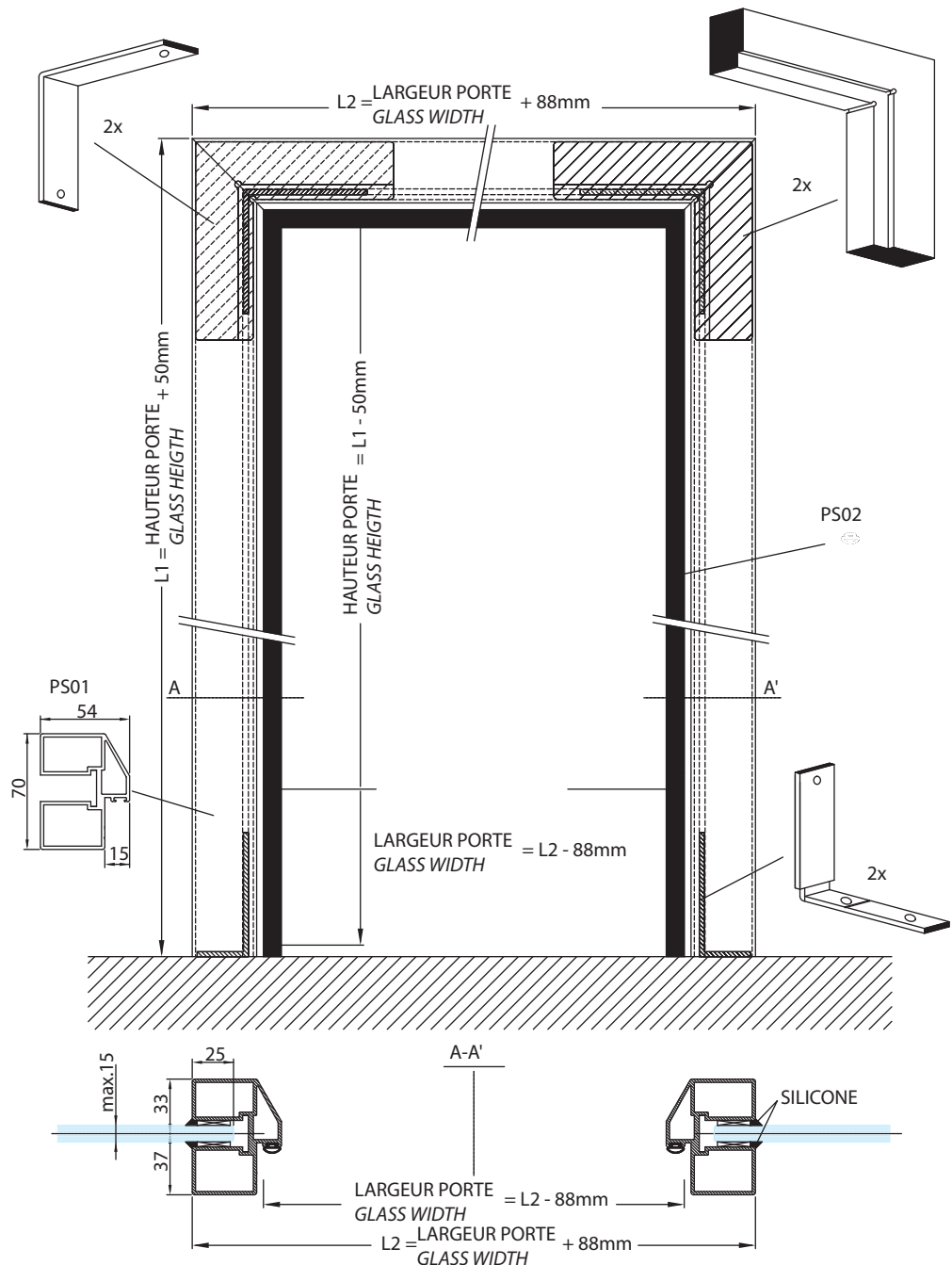



PS01MST

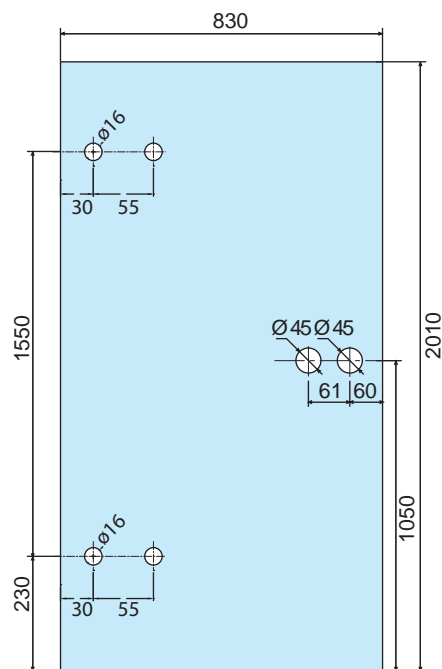

Références / References



Aluminium anodisé Argent Brossé
Brushed anodised alu silver

Aluminium anodisé Aninox
Brushed anodised alu.

Kit complet profil d'encadrement porte en verre de 830 x 2010 mm
avec serrure V525 et paumelles V504
Complete Kit door frame profile for 830 x 2010 mm glass doors with lock V525
and hinges V504

PS01MST.12

PS01MST.36

PS

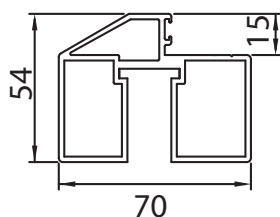

Références / References



Aluminium anodisé Argent Brossé
Brushed anodised alu silver

Aluminium anodisé Aninox
Brushed anodised alu.

Profil d'encadrement vertical longueur 2500 mm
2500 mm length profile for vertical door frame

PS2500.12

PS2500.36

Profil d'encadrement horizontal longueur 1500 mm
1500 mm length profile for horizontal door frame

PS1500.12

PS1500.36

PS02.99



Références / References

Joint pour encadrement porte en verre
Rubber strip for door frame

PS09.99

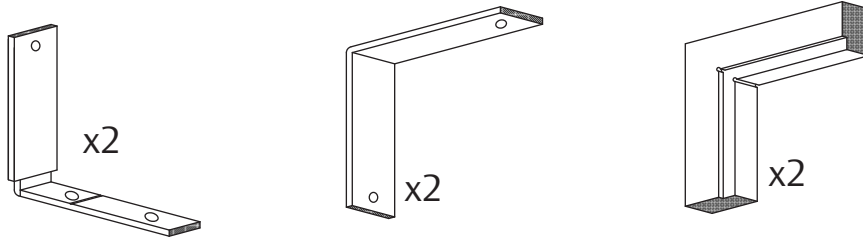

Serrures et
paumelles
Locksets and
hinges

Kit de fixation d'angle pour profil encadrement PS01, vis de fixation inclus
Corner mounting kit for doorframe profil PS01, including fixing screws

V504

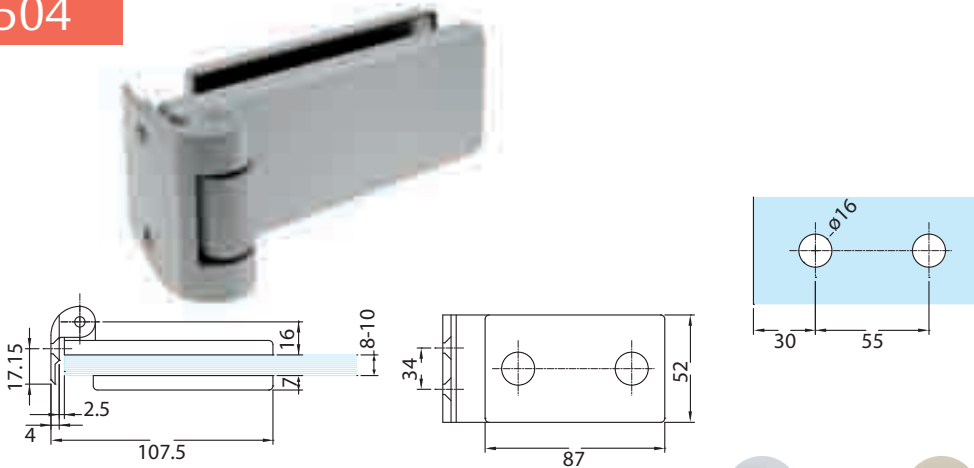

Références / References

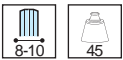

Aluminium anodisé Argent Brossé
Brushed anodised alu silver

Aluminium anodisé Aninox
Brushed anodised alu.

V504.12

V504.36

Paumelle et fiche pour profil alu encadrement porte en verre PS01
Hinge and multi rebate butt for door frame aluminium profile for glass door PS01

RS02.99

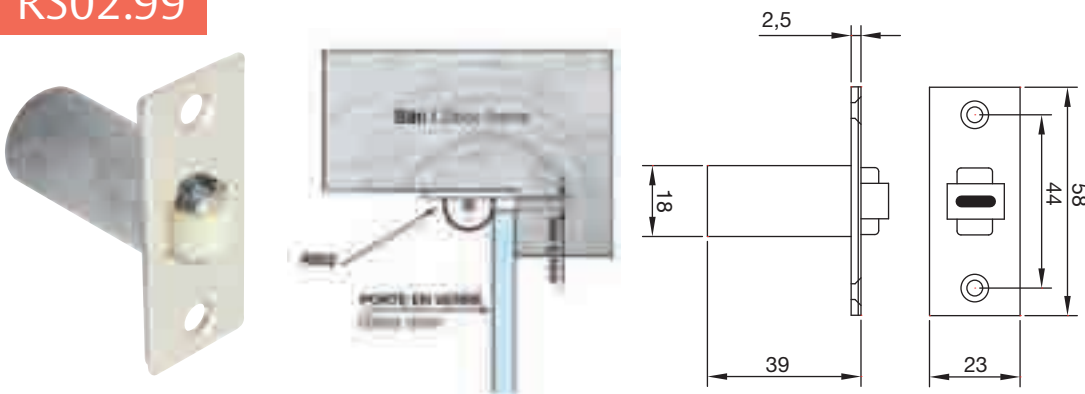

Galet avec rouleau nylon, réglable
Blocking roller keep, adjustable

Serrures et
paumelles
Locksets and
hinges

2800.66.*

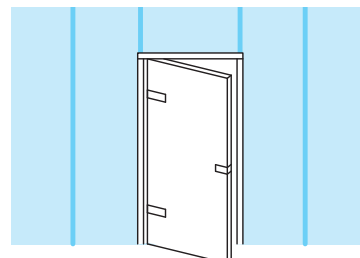
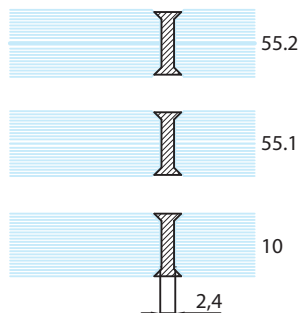
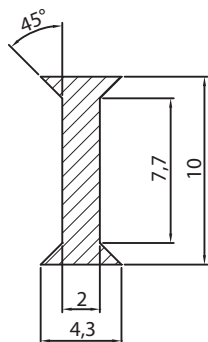

Références / References

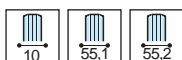

Joint PVC pour verre 10 mm - 55,1 - 55,2 adhésif inclus pour joindre 2 panneaux fixes
Dry glazing profile for glass 10 mm - 55,1 - 55,2 including tape for jointing 2 fixed panels

2800.66.1

2800.66.0

- Unité de vente : 1 joint conditionné par 10
- Sold in units : packed by 10

2802.66.*

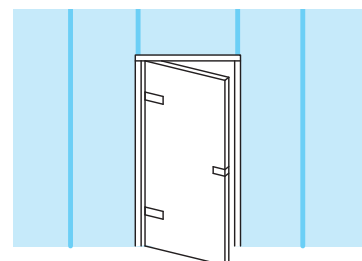
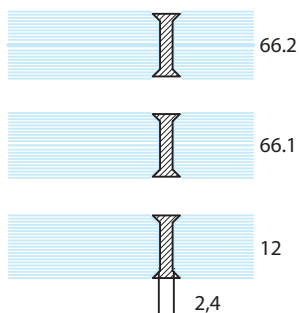
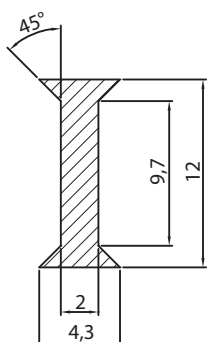

Références / References

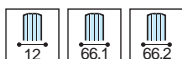

Joint PVC pour verre 12 mm - 66,1 - 66,2 adhésif inclus pour joindre 2 panneaux fixes
Dry glazing profile for glass 12 mm - 66,1 - 66,2 including tape for jointing 2 fixed panels

2802.66.1

2802.66.0

- Unité de vente : 1 joint conditionné par 10
- Sold in units : packed by 10

LES + PRODUITS

Esthétique

Installation

Attractive design

Easy installation



Paumelles *Hinges*

LAGUNE & LUMIRA

Caractéristiques techniques

- Pour verre trempé de 8 à 10 mm
- Montage sur encoche 6200EF
- Dimension maximum des portes 827 mm x 2034 mm
- Poids maximum admissible 45 kg pour 2 paumelles, pour un poids supérieur pose obligatoire d'une 3ème paumelle

Technical features

- For 8 to 10 mm thick toughened glass
- To fit notch 6200EF
- Dimensions size of doors 827 mm x 2034 mm
- Max load 45 kg for 2 hinges, for load exceeding a third hinge must be fitted



LES + PRODUITS

Design des serrures
Lagune et Lumira

*Lagune and Lumira
lock design*



4200

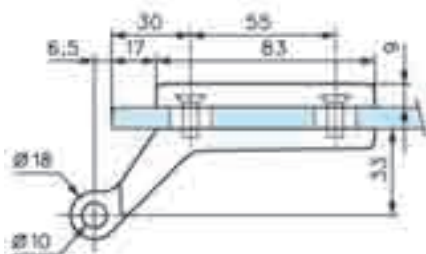
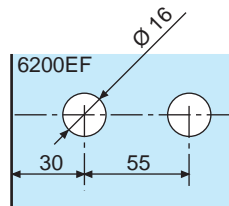

Références / References

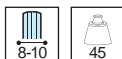

Chromé brillant
Bright chromium



Chromé mat
Matt chromium



Effet inox
Stainless steel effect



Doré
Gold plated



Laqué blanc 9010
Lacquered white RAL 9010

Paumelle pour feuillures de 35 à 40 mm, s'utilise avec les fiches 3204 - 3205 - 3206
Hinge for rebate of 35 to 40 mm, to fit butts 3204 - 3205 - 3206

4200.30.0

4200.31.0

4200.35.0

4200.40.0

4200.51.0

4201

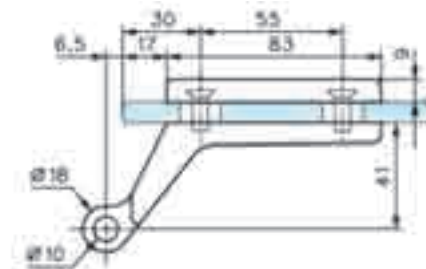
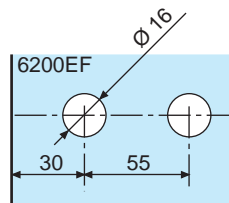

Références / References

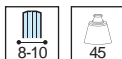

Chromé brillant
Bright chromium



Chromé mat
Matt chromium



Effet inox
Brushed stainless steel



Doré
Gold plated



Laqué blanc 9010
Lacquered white RAL 9010

Paumelle pour feuillures supérieures à 40 mm, s'utilise avec les fiches 3204 - 3205 - 3206
Hinge for rebate larger than 40 mm, to fit butts 3204 - 3205 - 3206

4201.30.0

4201.31.0

4201.35.0

4201.40.0

4201.51.0

Serrures et
paumelles
Locksets and
hinges

4203

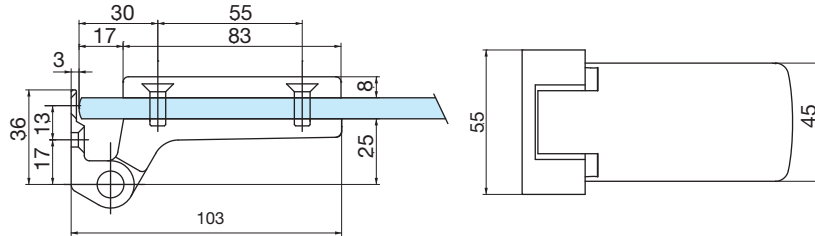
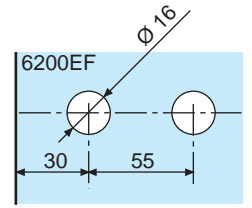

Références / References



Chromé brillant
Bright chromium



Chromé mat
Matt chromium



Effet inox
Stainless steel effect



Doré
Gold plated



Laqué blanc 9010
Lacquered white RAL 9010

Paumelle et fiche multi feuillure pour
tous types d'huisseries
Hinge and multi rebate butt for all types
of frame

4203.30.0

4203.31.0

4203.35.0

4203.40.0

4203.51.0

LES + PRODUITS

Montage facile
Tout support

Easy installation
Fits to all kinds
of frame

V504

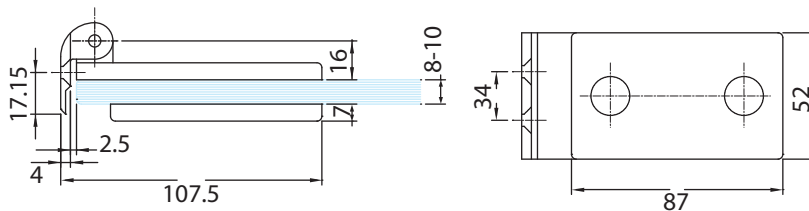
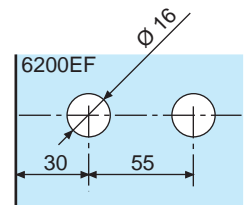

Références / References



Aluminium anodisé Argent Brossé
Brushed anodised alu silver



Aluminium anodisé Aninox
Brushed anodised alu.

Paumelle et fiche pour profil alu encadrement porte en verre PS01
Hinge and multi rebate butt for door frame profile for glass door PS01

V504.12

V504.36

V505

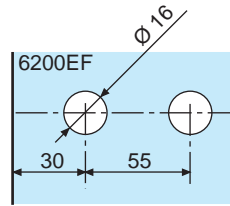

Serrures et
paumelles
Locksets and
hinges

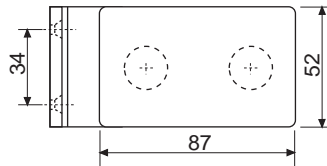
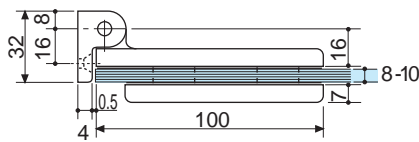

Références / References



Laiton poli verni
Polished varnished brass



Aluminium anodisé Argent Brossé
Brushed anodised alu silver



Chromé brillant
Bright chromium



Chromé mat brossé
Brushed matt chromium



Aluminium anodisé Aninox
Brushed anodised alu.

Paumelle et fiche multi feuillure
pour tous types d'huisseries
Hinge and multi rebate butt for all
types of frame

V505.01

V505.12

V505.30.0

V505.33

V505.36

V507

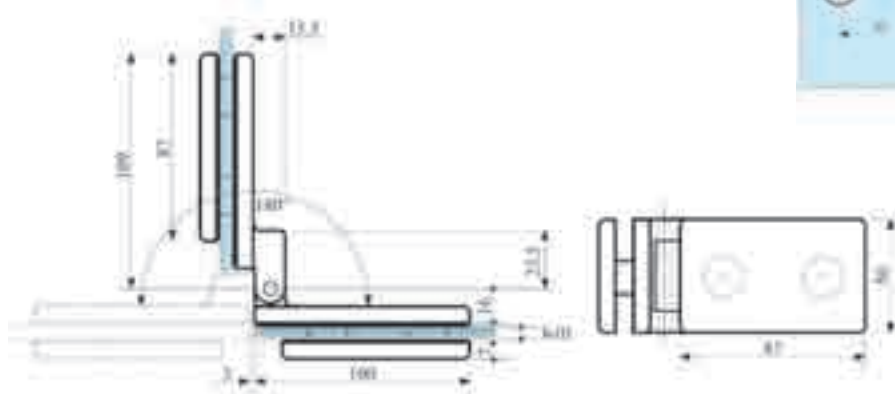
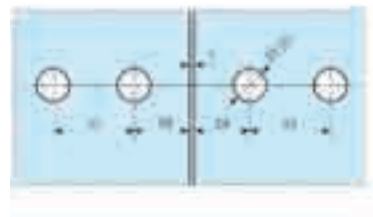

Références / References



Paumelle double verre/verre pour portes simple action
Glass to glass hinge for single action doors



Laiton poli verni
Polished varnished brass



Aluminium anodisé Argent Brossé
Brushed anodised alu silver



Aluminium anodisé noir
Anodised alu black



Chromé brillant
Bright chromium



Chromé mat brossé
Brushed matt chromium



Aluminium anodisé Aninox
Brushed anodised alu.

V507.01

V507.12

V507.19

V507.30.0

V507.33

V507.36

3204

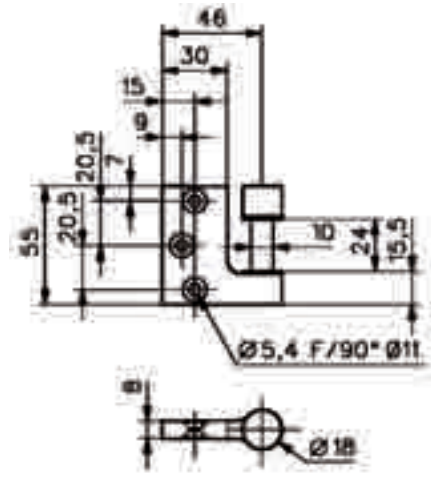
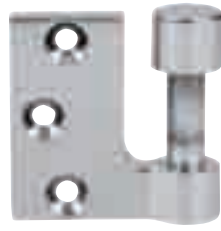

Chromé brillant
Bright chromium



Chromé mat
Matt chromium



Doré
Gold plated



Laqué blanc 9010
Lacquered white RAL 9010

Références / References

Fiche à entailler réversible pour huisseries bois,
s'utilise avec les paumelles 4200 et 4201
Reversible flush fixed butt for wooden door frame,
to fit to hinges 4200 and 4201

3204.30.0

3204.31.0

3204.40.0

3204.51.0

3206.**.0

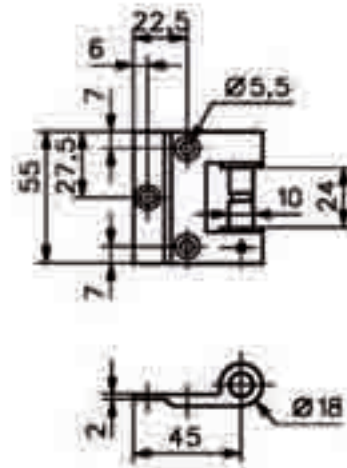

Laiton poli
Polished brass



Chromé brillant
Bright chromium



Chromé mat
Matt chromium



Doré
Gold plated



Laqué blanc 9010
Lacquered white RAL 9010

Références / References

Fiche en applique réversible
pour toutes huisseries bois, métalliques
et aluminium, s'utilise avec les paumelles
4200 et 4201
Reversible surface fixed butt for all types of
wooden, metal and aluminium frame, to fit
to hinges 4200 and 4201

3206.00.0

3206.30.0

3206.31.0

3206.40.0

3206.51.0

3205.**.1

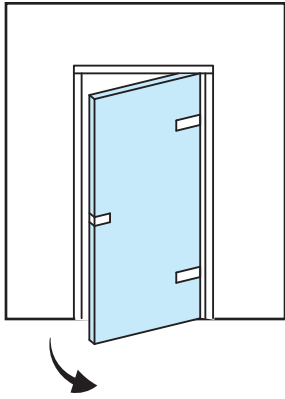
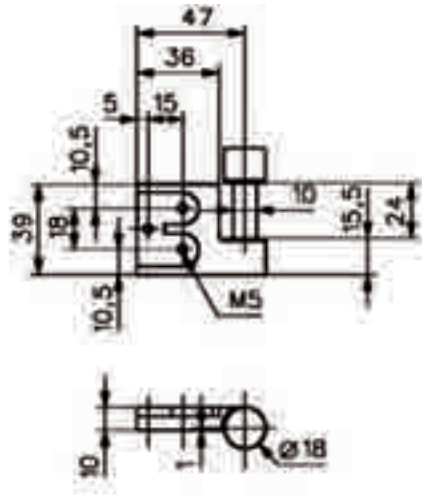

Laiton poli
Polished brass



Chromé brillant
Bright chromium



Chromé mat
Matt chromium



Doré
Gold plated

Références / References

Fiche à entailler (main droite) non réversible pour huisseries métalliques, s'utilise avec les paumelles 4200 et 4201

Non reversible mortised butt (right hand) for metal frame, to fit hinges 4200 and 4201

3205.00.1

3205.30.1

3205.31.1

3205.40.1

3205.**.2

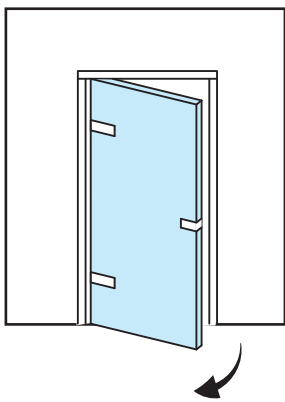
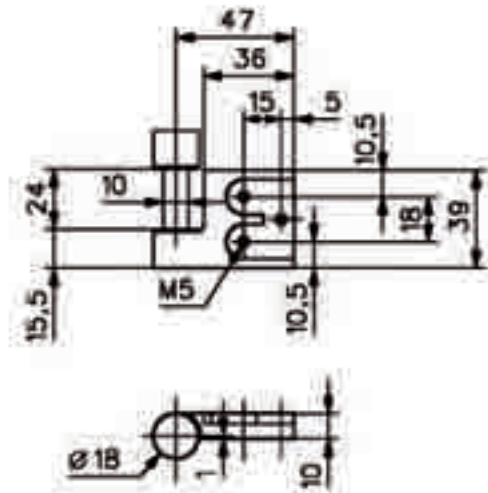

Laiton poli
Polished brass



Chromé brillant
Bright chromium



Chromé mat
Matt chromium



Doré
Gold plated

Références / References

Fiche à entailler (main gauche) non réversible pour huisseries métalliques, s'utilise avec les paumelles 4200 et 4201

Non reversible mortised butt (left hand) for metal frame, to fit hinges 4200 and 4201

3205.00.2

3205.30.2

3205.31.2

3205.40.2

Paumelles *Hinges*

BASTILLE

Caractéristiques techniques

- Pour verre trempé de 8, 10 et 12 mm
- Montage sur encoche 6202EX
- Poids maximum admissible 45 kg pour 2 paumelles, largeur maximum 1000 mm, pour un poids supérieur nous consulter

Technical features

- For 8, 10 and 12 mm thick toughened glass
- To fit notch 6202EX
- Max load 45 kg, maximum width 1000 mm, for 2 hinges please consult us for glass weighting more than 45 kg



LES + PRODUITS

Montage facile
Tout support

Easy installation
Fit to all kind of frame

4202

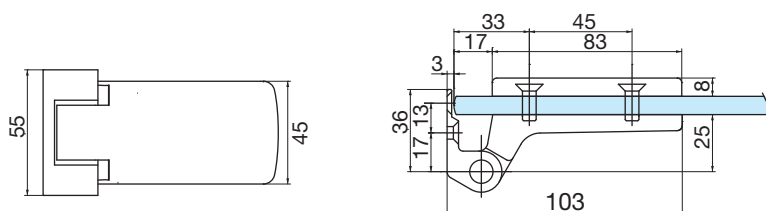
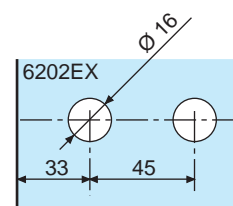

Références / References

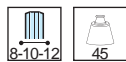

Laiton poli PVD
Polished brass PVD



Chromé brillant
Bright chromium



Chromé mat
Matt chromium



Effet inox
Stainless steel effect



Laqué blanc 9010
Lacquered white RAL 9010

Paumelle et fiche multi feuillure pour
tous types d'huisseries

*Hinge and multi rebate butt for all
types of frame*

4202.05.0

4202.30.0

4202.31.0

4202.35.0

4202.51.0

4206

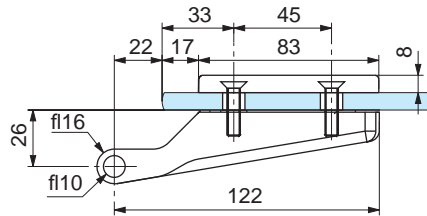
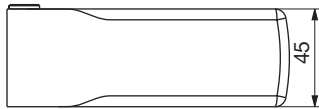
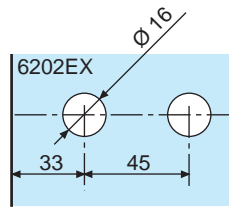

Références / References



Laiton poli PVD
Polished brass PVD



Chromé brillant
Bright chromium



Chromé mat
Matt chromium



Effet inox
Stainless steel effect



Laqué blanc 9010
Lacquered white RAL 9010

Paumelle pour feuillure de 24 mm,
s'utilise avec les fiches 4207 - 4208 - 4209
Hinge for rebate of 24 mm, to fit butts
4207 - 4208 - 4209

4206.05.0

4206.30.0

4206.31.0

4206.35.0

4206.51.0

V505.2

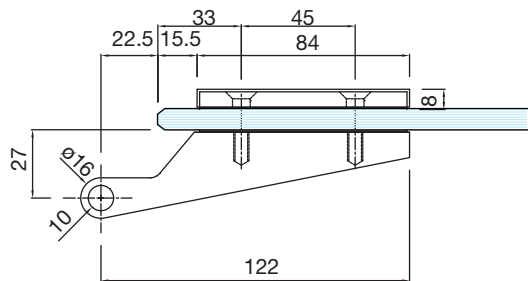
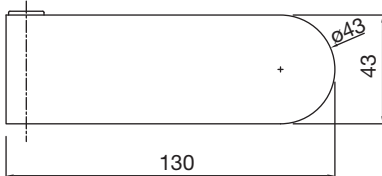
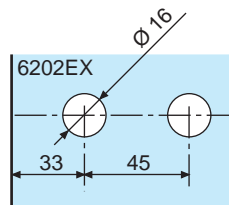

Références / References



Laiton poli Verni
Polished varnished brass



Aluminium anodisé Argent Brossé
Brushed anodised alu silver



Inox Brossé
Brushed stainless steel



Aluminium anodisé Aninox
Brushed anodised alu.

Paumelle pour feuillure de 24 mm, s'utilise
avec les fiches 4207 - 4208 - 4209
Hinge for rebate of 24 mm, to fit butts
4207 - 4208 - 4209

V505.2.01

V505.2.12

V505.2.15

V505.2.36

4207.99.0

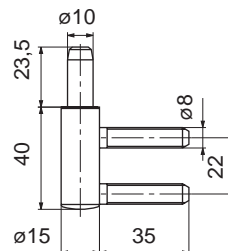

Fiche pour huisseries bois, s'utilise avec la paumelle 4206 et caches fiches 4205
Butt for wooden door frame, to fit hinge 4206 and butt covers 4205

4208.99.0

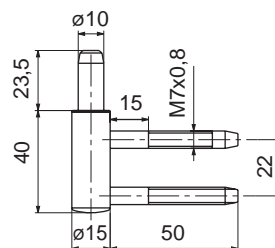

Fiche pour huisseries bois, s'utilise avec la paumelle 4206 et caches fiches 4205
Butt for wooden door frame, to fit hinge 4206 and butt covers 4205

4209.99.0

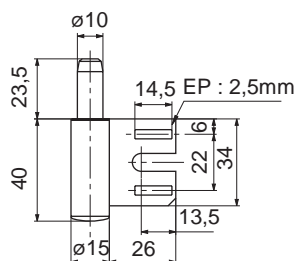

Fiche pour huisseries métalliques, s'utilise avec la paumelle 4206 et caches fiches 4205
Butt for metal door frame, to fit hinge 4206 and butt covers 4205

K3172.90

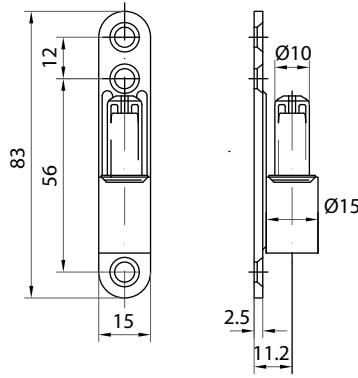

Fiche en applique réversible pour toutes huisseries bois, métalliques et aluminium, s'utilise avec les paumelles 4206 - V505.2 et caches fiches 4205 - V207
 Reversible surface fixed butt for all types of wooden, metal and aluminium frame, to fit hinges 4206 - V505.2 and butt covers 4205 - V207

4205

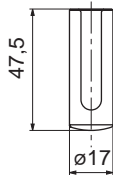

Références / References

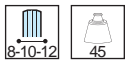

Laiton poli PVD
Polished brass PVD



Chromé brillant
Bright chromium



Chromé mat
Matt chromium



Effet inox
Stainless steel effect



Laqué blanc 9010
Lacquered white RAL 9010

Caches pour fiches 4207 - 4208 - 4209
Covers for butt 4207 - 4208 - 4209

4205.05.0

4205.30.0

4205.31.0

4205.35.0

4205.51.0

Paumelles *Hinges*

LUMIRA VERTICALE

Caractéristiques techniques

- Pour verre trempé de 8 et 10 mm
- Montage sur encoche V380E
- Poids maximum admissible 45 kg pour 2 paumelles, largeur maximum 1000 mm, pour un poids supérieur nous consulter

Technical features

- For 8 and 10 mm thick toughened glass
- To fit notch V380E
- Max load 45 kg, maximum width 1000 mm, for 2 hinges please contact us for glass weighing more than 45 kg

V380

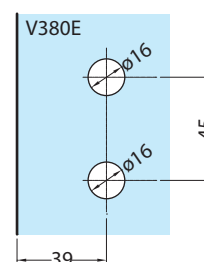
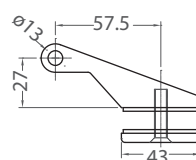
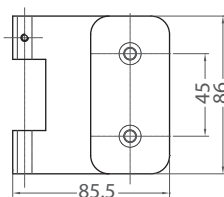

Aluminium anodisé Argent Brossé
Brushed anodised alu silver



Aluminium anodisé Aninox
Brushed anodised alu.

Références / References

Paumelle pour feuillure de 35 mm, s'utilise avec les fiches V206 – V208 – V209
Hinge for rebate of 35 mm, to fit butts V206 – V208 – V209

V380.12

V380.36

V206.15

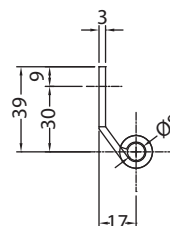
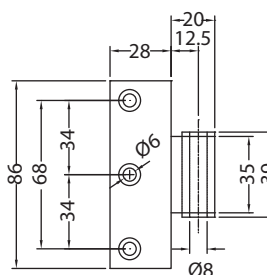

Références / References

Fiche en applique réversible pour toutes huisseries bois, métalliques et aluminium, s'utilise avec la paumelle V380 et cache fiche V207
Reversible surface fixed butt for all types of wooden, metal and aluminium frames, to fit hinge V380 and butt covers V207

V208.15

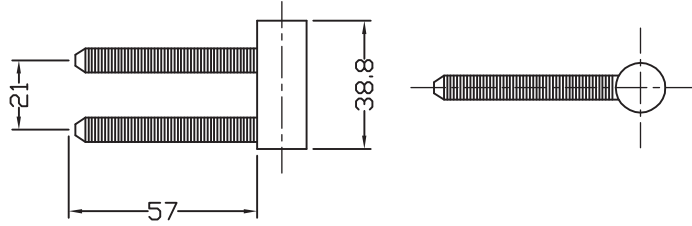

Références / References

Fiche pour huisseries bois, s'utilise avec la paumelle V380 et cache fiche V207
Butt for wood door frame, to fit hinge V380 and butt covers V207

V209.15

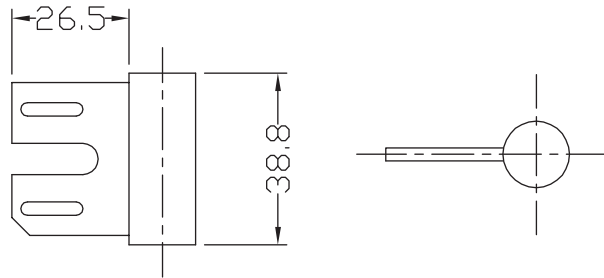

Références / References

Fiche pour huisseries métalliques, s'utilise avec la paumelle V380 et cache fiche V207
Butt for metal door frame, to fit hinge V380 and butt covers V207

V207

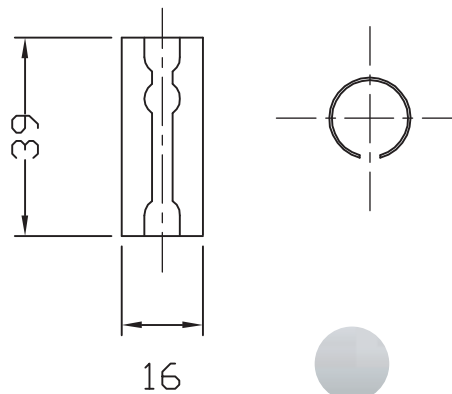

Références / References



Cache pour fiches V206 – V208 – V209
Covers for butt V206 – V208 – V209

Aluminium anodisé Argent Brossé
Brushed anodised alu silver

V207.12

Aluminium anodisé Aninox
Brushed anodised alu.

V207.36

SWINGO

Caractéristiques techniques

- Blocage à 90°
- Testée pour 500 000 cycles
- Pour verre trempé de 8 et 10 mm
- Poids maximum admissible 60 kg pour 2 charnières
- Largeur maximum de la porte 900 mm
- Montage sur encoche V861E
- Livrée avec joints et vis de fixation

Technical features

- Blocking points at 90°
- Tested for 500,000 cycles
- For 8 and 10 mm thick toughened glass
- Max load 60 kg for 2 hinges
- Width of the door 900 mm
- Assembly on notch V861E
- Delivered with spacers and fixing screws

LES + PRODUITS

The + product

Design

Fermeture
automatique
de la porte

Installation facile
et discrète

Elegant design

Automatic door closing

*Easy and discreet
installation*



4861

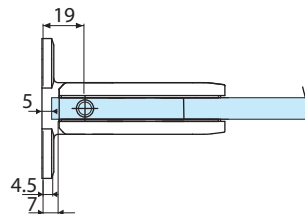
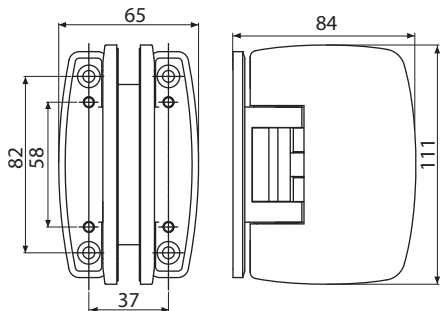
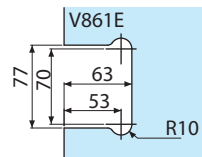

Références / References

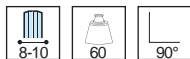

Chromé brillant
Bright chromium



Chromé mat
Matt chromium



Effet inox
Stainless steel effect



Laqué blanc 9010
Lacquered white RAL 9010

Charnière simple mur/verre à rappel automatique
Single hinge wall/glass automatic return

4861.30.0

4861.31.0

4861.35.0

4861.51.0

4862

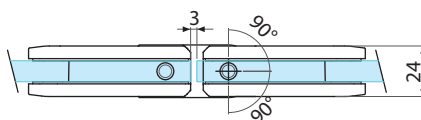
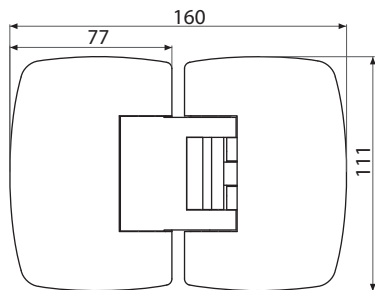
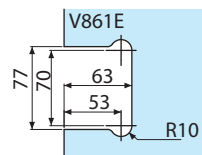

Références / References



Chromé brillant
Bright chromium



Chromé mat
Matt chromium



Effet inox
Stainless steel effect



Laqué blanc 9010
Lacquered white RAL 9010

Charnière double verre/verre à rappel automatique
Glass to glass automatic return hinge

4862.30.0

4862.31.0

4862.35.0

4862.51.0

Serrures et
paumelles
Locksets and
hinges

Pentures *Hinges* LUMIRA

Caractéristiques techniques

- Pour verre trempé épaisseur 8, 10 et 12 mm
- Poids maximum admissible 75 kg
- Dimensions maxi pour portes en verre 900 x 2200 mm
- Montage sur encoche V590E

Technical features

- For 8, 10 and 12 mm thick toughened glass
- Max load 75 kg
- Maximum size for glass doors 900 x 2200 mm
- Assembly on notch V590E

V590



LES + PRODUITS

The + product

Idéal pour portes
lourdes ou
grand format

Ideal for heavy and
large doors

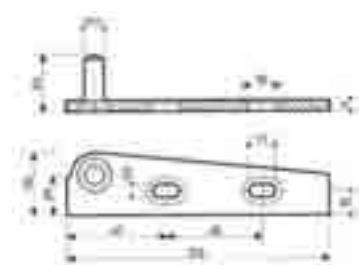
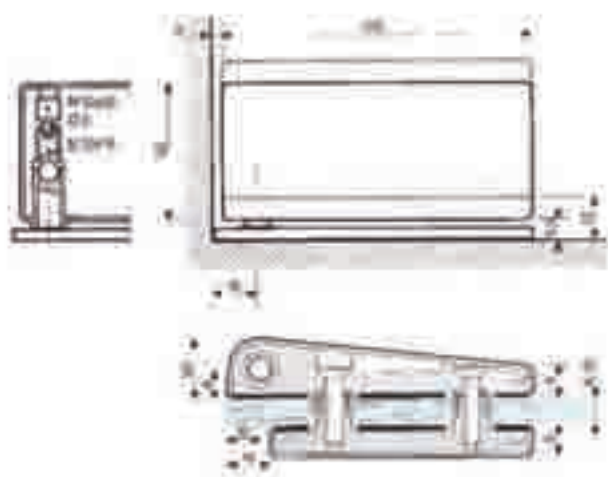
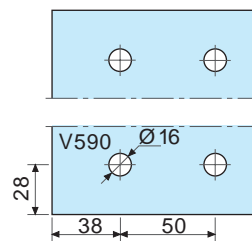
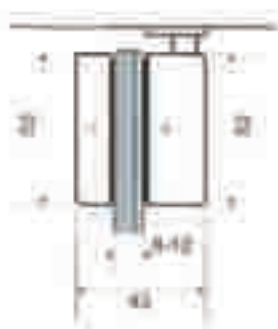

Références / References

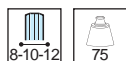

Laiton poli verni
Polished varnished brass



Aluminium anodisé Argent Brossé
Brushed anodised alu silver



Chromé brillant
Bright chromium



Chromé mat brossé
Brushed matt chromium



Aluminium anodisé Aninox
Brushed anodised alu.

Pentures déportées basse et
haute avec platines

Top and bottom offset pivot
hinges with mounting plate

V590.01

V590.12

V590.30.0

V590.33

V590.36

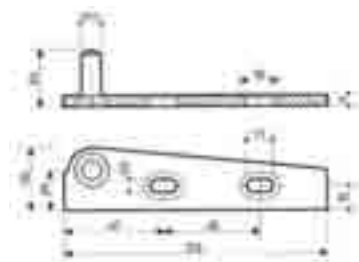
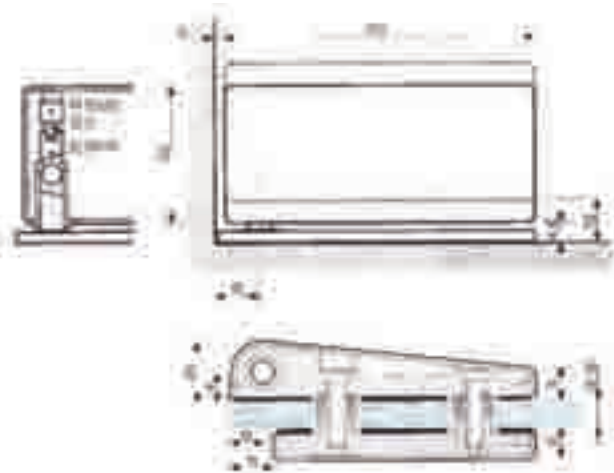
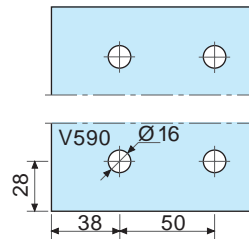
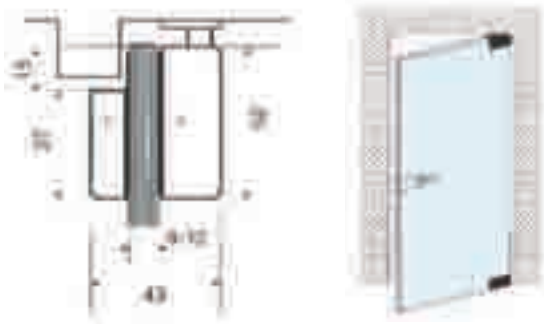

Références / References



Laiton poli verni
Polished varnished brass

V592.01



Aluminium anodisé Argent Brossé
Brushed anodised alu silver

V592.12



Chromé brillant
Bright chromium

V592.30.0



Chromé mat brossé
Brushed matt chromium

V592.33



Aluminium anodisé Aninox
Brushed anodised alu.

V592.36

Pentures déportées basse et haute avec platines, penture supérieure raccourcie
Top and bottom offset pivot hinges with mounting plate, top hinge with reduced

V593



LES + PRODUITS

The + product

Idéal pour portes
lourdes ou grand
format

Idéal for large and
heavy doors

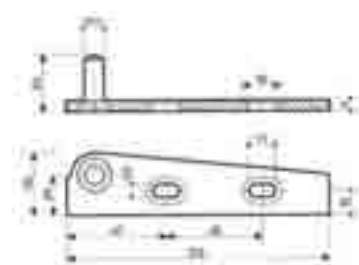
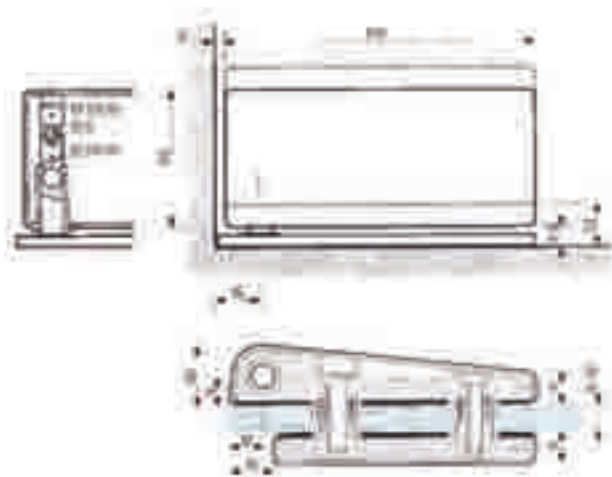
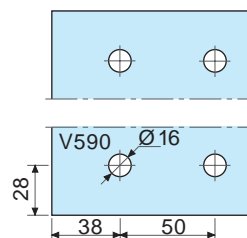

Références / References



Laiton poli verni
Polished varnished brass



Aluminium anodisé Argent Brossé
Brushed anodised alu silver



Chromé brillant
Bright chromium



Chromé mat brossé
Brushed matt chromium



Aluminium anodisé Aninox
Brushed anodised alu.

Pentures déportées basse et
haute avec platines, penture
supérieure raccourcie

Top and bottom offset pivot
hinges with mounting plate, top
hinge with adapted back plate

V593.01

V593.12

V593.30.0

V593.33

V593.36